

SFS60663



**PLEASE CHECK FOR CHANGE INFORMATION
AT THE REAR OF THIS MANUAL.**

**176
PULSED HIGH
CURRENT
FIXTURE**

INSTRUCTION MANUAL

Tektronix, Inc.
P.O. Box 500
Beaverton, Oregon 97077
070-1073-00
Product Group 48

Serial Number _____

First Printing OCT 1970
Revised JAN 1983

Copyright © 1970 Tektronix, Inc. All rights reserved.
Contents of this publication may not be reproduced in any
form without the written permission of Tektronix, Inc.

Products of Tektronix, Inc. and its subsidiaries are covered
by U.S. and foreign patents and/or pending patents.

TEKTRONIX, TEK, SCOPE-MOBILE, and  are
registered trademarks of Tektronix, Inc. TELEQUIPMENT
is a registered trademark of Tektronix U.K. Limited.

Printed in U.S.A. Specification and price change privileges
are reserved.

INSTRUMENT SERIAL NUMBERS

Each instrument has a serial number on a panel insert, tag,
or stamped on the chassis. The first number or letter
designates the country of manufacture. The last five digits
of the serial number are assigned sequentially and are
unique to each instrument. Those manufactured in the
United States have six unique digits. The country of
manufacture is identified as follows:

B000000	Tektronix, Inc., Beaverton, Oregon, USA
100000	Tektronix Guernsey, Ltd., Channel Islands
200000	Tektronix United Kingdom, Ltd., London
300000	Sony/Tektronix, Japan
700000	Tektronix Holland, NV, Heerenveen, The Netherlands

TABLE OF CONTENTS

	Page		Page
Section 1 SPECIFICATION		Section 4 CIRCUIT DESCRIPTION	
Electrical Characteristics	1-1	Block Diagram Description	4-1
Environmental Characteristics	1-4	Circuit Description	4-1
Section 2 OPERATING INSTRUCTIONS		Section 5 PERFORMANCE CHECK AND ADJUST	
Installation	2-1	General	5-1
Cooling	2-1	Performance Check Procedure	5-1
Controls, Indicator Lights and Connectors	2-1	Adjust Procedure	5-5
General Description	2-2	Section 6 ELECTRICAL PARTS LIST	
Effects of 176 on Type 576 Controls . .	2-4	Section 7 DIAGRAMS, CIRCUIT BOARD PICTURES AND MECHANICAL PARTS ILLUSTRATIONS	
First Time Operation	2-5	General Information	7-1
		Block Diagram	
		Circuit Diagrams and Circuit Board Pictures	
		Mechanical Parts Illustrations	
		Section 8 MECHANICAL PARTS LIST	
		CHANGE INFORMATION	
		Abbreviations and symbols used in this manual are based on or taken directly from IEEE Standard 260 "Standard Symbols for Units", MIL-STD-12B and other standards of the electronics industry.	

WARNING

THE REMAINING PORTION OF THIS TABLE OF CONTENTS LISTS THE SERVICING INSTRUCTIONS. THESE SERVICING INSTRUCTIONS ARE FOR USE BY QUALIFIED PERSONNEL ONLY. TO AVOID ELECTRICAL SHOCK, DO NOT PERFORM ANY SERVICING OTHER THAN THAT CALLED OUT IN THE OPERATING INSTRUCTIONS UNLESS QUALIFIED TO DO SO.

Section 3 MAINTENANCE	
Index of Maintenance Information	3-1
Preventive Maintenance	3-2
Troubleshooting	3-2
Corrective Maintenance	
Obtaining Replacement Parts	3-3
Tuning the Charge Lines	3-4
Charge Line Coil Replacement	3-5
Semiconductor Replacement	3-6
Relay Removal and Replacement	3-6
Pushbutton Bulb Replacement	3-6
Soldering on Circuit Boards	3-6

OPERATORS SAFETY SUMMARY

The general safety information in this part of the summary is for both operating and servicing personnel. Specific warnings and cautions will be found throughout the manual where they apply, but may not appear in this summary.

TERMS

In This Manual

CAUTION statements identify conditions or practices that could result in damage to the equipment or other property.

WARNING statements identify conditions or practices that could result in personal injury or loss of life.

As Marked on Equipment

CAUTION indicates a personal injury hazard not immediately accessible as one reads the marking, or a hazard to property including the equipment itself.

DANGER indicates a personal injury hazard immediately accessible as one reads the marking.

SYMBOLS

In This Manual



This symbol indicates where applicable cautionary or other information is to be found.

As Marked on Equipment



DANGER — High voltage.



Protective ground (earth) terminal.



ATTENTION — refer to manual.

Power Source

This product is intended to operate from a power module connected to a power source that will not apply more than 250 volts rms between the supply conductors or between either supply conductor and ground. A protective ground connection by way of the grounding conductor in the power cord is essential for safe operation.

Grounding the Product

This product is grounded through the grounding conductor of the power module power cord. To avoid electrical shock, plug the power cord into a properly wired receptacle before connecting to the product input or output terminals. A protective ground connection by way of the grounding conductor in the power module power cord is essential for safe operation.

Danger Arising From Loss of Ground

Upon loss of the protective-ground connection, all accessible conductive parts (including knobs and controls that may appear to be insulating) can render an electric shock.

Use the Proper Fuse

To avoid fire hazard, use only the fuse of correct type, voltage rating and current rating as specified in the parts list for your product.

Refer fuse replacement to qualified service personnel.

Do Not Operate in Explosive Atmospheres

To avoid explosion, do not operate this product in an explosive atmosphere unless it has been specifically certified for such operation.

Do Not Operate Without Covers

To avoid personal injury, do not operate this product without covers or panels installed. Do not apply power to the plug-in via a plug-in extender.

SERVICE SAFETY SUMMARY

FOR QUALIFIED SERVICE PERSONNEL ONLY

Refer also to the preceding Operators Safety Summary.

Do Not Service Alone

Do not perform internal service or adjustment of this product unless another person capable of rendering first aid and resuscitation is present.

Use Care When Servicing With Power On

Dangerous voltages may exist at several points in this product. To avoid personal injury, do not touch exposed connections and components while power is on.

Disconnect power before removing protective panels, soldering, or replacing components.

Power Source

This product is intended to operate from a power source that will not apply more than 250 volts rms between the supply conductors or between either supply conductor and ground. A protective ground connection by way of the grounding conductor in the power cord is essential for safe operation.

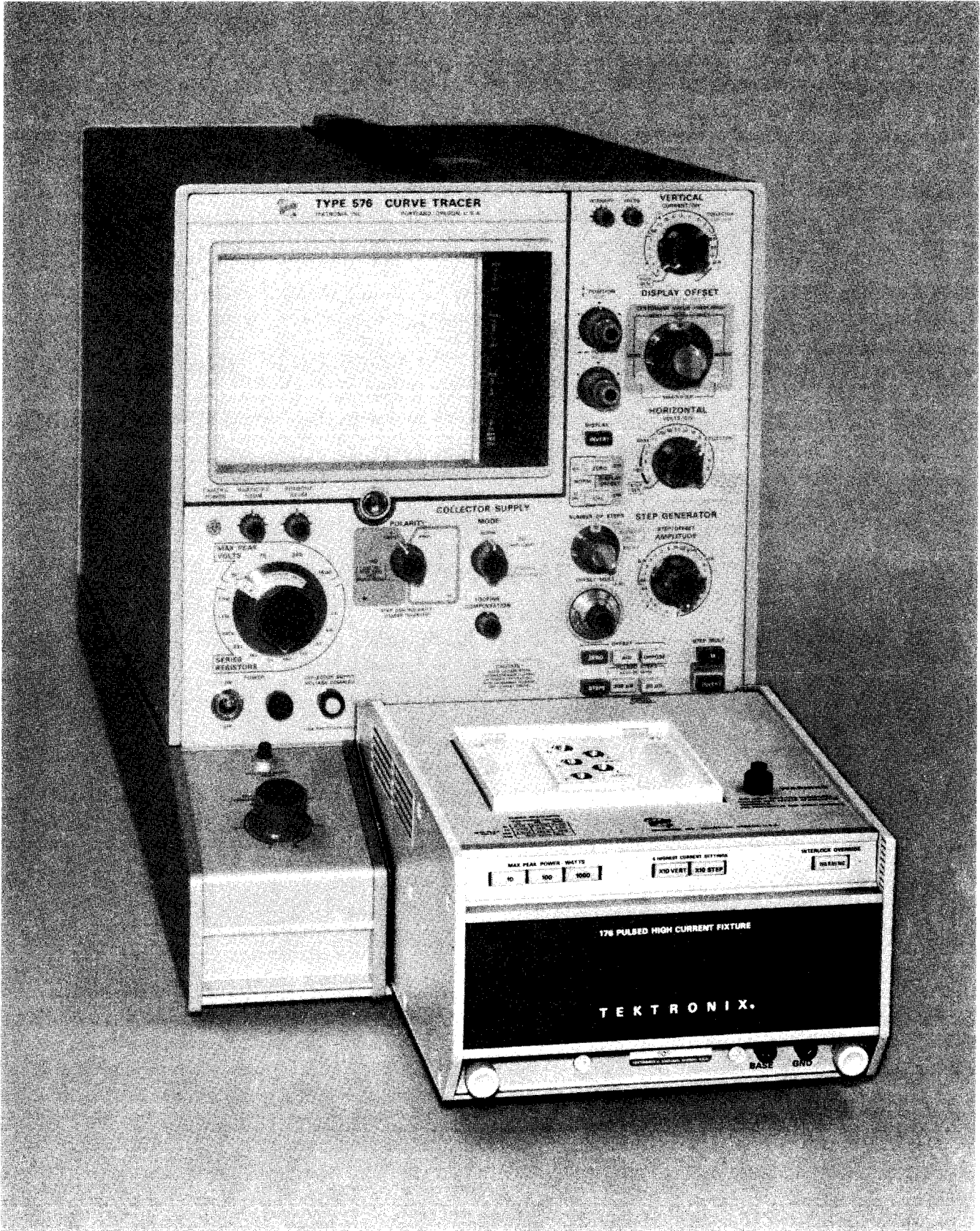

Fig. 1-1. 176 High-Current Fixture.

SECTION 1

SPECIFICATION

The 176 Pulsed High-Current Fixture extends the testing capability of the Type 576 Curve Tracer by providing a pulsed collector supply output of up to 200 A peak and a pulsed step generator output of up to 20 A peak. To accommodate this increased range, the maximum peak power output has been increased to 1000 watts and the maximum vertical deflection factor has been increased to 20 A/division.

The 176 slides into the Type 576 in place of the Standard Test Fixture. A set of 5 accessories jacks is available, which accepts most Tektronix device testing accessories. Kelvin sensing of collector voltage may be used for all tests. An interlock system is used, which allows tests to be made only when a protective box is in place over the device under test, thus protecting users from dangerous

voltages. For remote tests, this interlock system may be overridden by a front panel button.

The following electrical and environmental characteristics are valid for a 176 operated in a calibrated Type 576, both instruments operated in an ambient temperature of between 0°C and +50°C.

The electrical characteristics are listed in two categories, performance requirements and supplementary information. The Performance Check and Adjust section provides a procedure for checking the characteristics listed in the performance requirement category. The characteristics listed in the supplementary information category are provided for the convenience of the user. A performance check procedure for the Type 576 is available in the Type 576 Instruction Manual.

TABLE 1-1
ELECTRICAL CHARACTERISTICS

Collector Supply		
Characteristic	Performance Requirement	Supplementary Information
Form of Output		300 μ s wide pulses. (80 μ s wide pulses also available but performance not specified.)
Repetition Rate		Power Line frequency
Polarity		Positive-going or negative-going as determined by Type 576 POLARITY switch.
Amplitude Ranges		15, 75 and 350 volts nominal, as determined by Type 576 MAX PEAK VOLTS switch.
Peak Voltage	Peak open circuit voltages within +35% and -5% of Type 576 MAX PEAK VOLTS switch setting for 75 and 350 positions; within +18% and -12% on 15 positions. All at nominal line voltage.	

TABLE 1-1 (cont)

Characteristic	Performance Requirement	Supplementary Information
Peak Current ¹	Minimum available peak current at low line into shorted load is: 200 A for 15 V range 40 A for 75 V range 8 A for 350 V range	
Pulse shape Flatness	15V Range: Within 2% during unblanking interval from 20% to 100% of maximum peak Collector Supply voltage. 75V & 350V Range: Within 2% during unblanking interval.	
Risetime		80 μ s (10% to 90%)
Falltime		10 μ s (90% to 10%)
Maximum Peak Power Output		1000 watts, 100 watts or 10 watts (Varies with line voltage).

Step Generator

Accuracy (Current steps and offset) Incremental accuracy X10 STEP button not illuminated		Refer to Type 576 Specification
X10 STEP button illuminated, 5 highest current settings only	Within 5% of 10 times Type 576 AMPLITUDE switch setting between any two steps without Type 576 .1X STEP MULT button pressed; within 10% of AMPLITUDE switch setting with .1X STEP MULT button pressed.	
Absolute Accuracy X10 STEP button not illuminated		Refer to Type 576 Specification
X10 STEP button illuminated, 5 highest current settings only	Within 3% of total output, plus 1% of ten times Type 576 AMPLITUDE switch setting, or 3% of ten times Type 576 AMPLITUDE switch setting, whichever is greater.	
Nominal Step Amplitudes X10 STEP button not illuminated		Refer to Type 576 Specification
X10 STEP button illuminated, 5 highest current settings only		Ten times (or one times with Type 576 .1X STEP MULT button pressed) Type 576 AMPLITUDE switch setting. Step amplitude is indicated on Type 576 PER STEP readout.

¹ Circuit breaker in Type 576 may open up if Type 576 VARIABLE COLLECTOR SUPPLY control has been left in its clockwise position for longer than 1/2 hour. It is advisable to leave the control in its counterclockwise position when not actually performing tests.

TABLE 1-1 (cont)

Characteristic	Performance Requirement	Supplementary Information
Type 576 OFFSET MULT control range		
X10 STEP button not illuminated		Refer to Type 576 Specification
X10 STEP button illuminated, 5 highest current settings only		Continuously variable from 0 to 100 times Type 576 AMPLITUDE switch setting, either aiding or opposing step generator polarity.
Maximum Current in Current Mode (Steps and Aiding Offset)		
X10 STEP button not illuminated		Refer to Type 576 Specification
X10 STEP button illuminated	200 times Type 576 AMPLITUDE switch setting or 20 A, whichever is less.	
Maximum Voltage in Current Mode (Steps and Aiding Offset)		
X10 STEP button not illuminated		Refer to Type 576 Specification
X10 STEP button illuminated, 5 highest current settings only	At least 5 volts with Type 576 AMPLITUDE switch set to 10 mA, 20 mA, or 50 mA at least 1.8 volts at 100 mA; at least 2 volts with AMPLITUDE switch set to 200 mA.	
Maximum Opposing Voltage and Current Mode (Steps and Opposing Offset)		
X10 STEP button not illuminated		Refer to Type 576 Specification
X10 STEP button illuminated		Polarity of step generator output cannot be reversed using oppose offset.
Step Rate		Power line frequency; Type 576 .5X RATE button pressed by projection on 176 rear panel.
Pulse Characteristics		
Width		300 μ s (80 μ s width also available but performance not specified).
Duty Cycle (300 μ s pulsed steps)		Approximately 2%
Step/Offset Polarity		Same as pulsed collector supply polarity. Reversible by pressing Type 576 STEP/OFFSET POLARITY INVERT button.
Vertical and Horizontal Display Amplifiers		
Display Accuracies		
Horizontal		Refer to Type 576 Specification

TABLE 1-1 (cont)

Characteristic	Performance Requirement	Supplementary Information
Vertical ² X10 VERT button not illuminated		Refer to Type 576 Specification
X10 VERT button illuminated, 5 highest collector current settings only	Within 3% of highest on-screen value when vertical display is unmagnified. When vertical display is magnified, within 4% with 0 to 10 divisions offset, 3% with 15 to 35 divisions offset and 2% with 40 to 100 divisions offset.	
Deflection factors Horizontal		Refer to Type 576 Specification
Vertical Collector Current X10 VERT button not illuminated		Refer to Type 576 Specification
X10 VERT button illuminated, 5 highest current settings only		1 A/division to 20 A/division in 1-2-5 sequence. Scale factor is indicated on Type 576 PER VERT DIV readout.

² Leakage (emitter current) measurements cannot be made when the 176 is being used.

TABLE 1-2
ENVIRONMENTAL CHARACTERISTICS

Characteristic	Performance Requirement	Supplementary Information
Temperature Non-operating	-40°C to +65°C	
Operating	0°C to +40°C	
Altitude Non-operating		To 50,000 feet
Operating		To 15,000 feet
Vibration (Non-operating)		15 minutes along each axis at 0.015 inch. Vary frequency from 10 to 50 to 10 c/s in 1-minute sweeps. Three minutes at any resonant point or at 50 c/s.
Shock (Non-operating)		30 g's, 1/2 sine, 11 ms duration, 2 shocks per axis
Transportation		Qualified under National Safe Transit Committee Test Procedure 1A

SECTION 2

OPERATING INSTRUCTIONS

INSTALLATION

To install the 176 in the Type 576, turn off the Type 576, remove the Standard Test Fixture and slide the 176 into place. Projections on the 176 rear panel press the STEP FAMILY REP and .5 X RATE buttons on the Type 576 when the 176 is in place. To hold the 176 in place, tighten the two fixture-securing screws on the front of the 176.

COOLING

The 176 has the same operating environment requirements as the Type 576. A fan is provided in the 176 which draws cooling air in through the front of the fixture and blows it out through louvered holes on the sides.

CONTROLS, INDICATOR LIGHTS AND CONNECTORS

The functions of all the front panel controls, indicator lights and connectors on the 176 (see Fig. 2-1) are described in the following table.

MAX PEAK POWER-WATTS Buttons	Select peak power output of pulsed collector supply. Each button lights when pressed.
X10 VERT Button	When pressed, increases the deflection factor for the five highest current positions of the Type 576



Fig. 2-1. 176 front-panel buttons, connectors and lights.

VERTICAL switch by 10. The PER VERT DIV readout indicates the new deflection factor. The button lights when pressed. The light goes out and the deflection factor returns to normal when the VERTICAL switch is turned clockwise beyond its five highest current positions.

X10 STEP Button When pressed, increases the step amplitude for the five highest current positions of the Type 576 AMPLITUDE switch by 10. The PER STEP readout indicates new step amplitudes. The button lights when pressed. The light goes out and the step amplitudes return to normal when the AMPLITUDE switch is turned counterclockwise beyond its five highest current positions.

Interlock Switch Enables the pulsed collector supply when the Type 576 COLLECTOR SUPPLY VOLTAGE DISABLED light is on. It is pressed when the protective box is in place and its lid is closed.

WARNING Light (Red) When lit indicates that the pulsed collector supply is enabled, and dangerous voltage may appear at the device testing jacks.

INTERLOCK OVERRIDE Button Enables the pulsed collector supply when the Type 576 COLLECTOR SUPPLY VOLTAGE DISABLED light is on. As a safety precaution, the action of the button is momentary.

WARNING

When the protective box is not in place, pressing the INTERLOCK OVERRIDE button makes operation of the instrument potentially hazardous. Operators should always be aware that dangerous voltages may appear at the device testing jacks when the red WARNING light is on.

Device Testing Jacks Allow connection of Tektronix made 2, 3 or 5-terminal Test Fixture Adapters to the 176. The jacks also accept standard size banana plugs for remote testing. The jacks labeled C, D and E are collector, base and emitter jacks, respectively. The jacks labeled CSENSE and ESENSE allow Kelvin sensing of collector and emitter voltages.

BASE Jack Base steps appear at this jack.

GROUND Jack Provides external access to ground reference.

Ground Connector A recessed sliding contact on left side of the 176, which grounds the 176 to the Type 576 chassis to prevent shock hazard.

GENERAL DESCRIPTION

The 176 High-Current Fixture extends the testing capabilities of the Type 576 Curve Tracer. Using the pulsed mode of operation, a device can be tested with pulsed currents of up to 200 amperes. Since these current pulses occur at a low duty cycle, a device can normally be tested without the use of heat sinks. Also, the chance of damaging the device is reduced.

Pulsed Collector Supply

The 176 pulsed collector supply produces current pulses which are either 300 μ s or 80 μ s in duration. These pulses are synchronized with the step generator output, and occur at line frequency rate (60 Hz or 50 Hz). The voltage amplitude of these pulses is determined by the Type 576 MAX PEAK VOLTS switch and VARIABLE COLLECTOR SUPPLY control. Three of the MAX PEAK VOLTS switch ranges (15, 75 and 350) are available for use with the 176. The Type 576 MAX PEAK POWER WATTS switch is disabled when the 176 is being used. The MAX PEAK POWER-WATTS buttons on the 176 provide power limiting of the pulsed collector supply. Power may be limited to 10, 100 or 1,000 watts.

The Type 576 interlock system is also used in the 176. When the yellow Type 576 COLLECTOR SUPPLY VOLTAGE DISABLED light is on, the pulsed collector supply is disabled. In this case either the protective box or the INTERLOCK OVERRIDE button can be used to enable the pulsed collector supply. The protective box fits over the device under test. When its lid is closed, the interlock switch is pressed, which enables the pulsed collector supply. Pressing the INTERLOCK OVERRIDE button also enables the pulsed collector supply. The INTERLOCK OVERRIDE button is used when the protective box cannot be used, either because the device under test is too large or it is in a remote location. Whenever the pulsed collector supply is enabled by the protective box or the INTERLOCK OVERRIDE button, the red 176 WARNING light goes on and the yellow Type 576 COLLECTOR SUPPLY VOLTAGE DISABLED light goes out.

WARNING

When the protective box is not in place, pressing the INTERLOCK OVERRIDE button makes operation of the instrument potentially hazardous. Operators should always be aware that when the red WARNING light is on, dangerous voltages may appear at the collector terminal of the device testing jacks.

Step Generator

When the 176 is being used, the Type 576 step generator must be operated in the pulsed steps mode. Using this mode, the step generator operates normally for all positions of the Type 576 AMPLITUDE switch except for its five highest current positions. The step amplitude for each of these five positions may be increased by 10 times by pressing the 176 X10 STEP button. The increased step amplitude is indicated by the PER STEP readout. With the X10 STEP button pressed, the maximum step generator output is 20 amperes. The X10 STEP button light will remain on until the AMPLITUDE switch is switched to a position below the 10 mA position. When the X10 STEP button light is out, the step generator operates normally.

NOTE

When the step generator is not in the highest 5 positions pushing the X10 STEP button will not change the step generator output but will change the readout.

Either 300 μ s or 80 μ s pulsed steps may be selected. If the Type 576 STEPS button is pressed, the 176 base step amplifier and pulsed collector supply are disabled. No damage results to the device under test.

When the X10 STEP button is illuminated, both the steps and the step offset, if any, are pulsed. Also, the range of the Type 576 OFFSET MULT control is increased, 10 times giving it a total range of 100 times the setting of the AMPLITUDE switch. When the X10 STEP button is not illuminated, only the steps are pulsed. In this case, the range of the OFFSET MULT control is 10 times the AMPLITUDE switch setting.

The step generator rate is always line frequency when the 176 is used, because a projection on the 176 rear panel automatically presses the Type 576 .5X RATE button when the 176 is installed. A similar projection presses the STEP FAMILY REP button.

NOTE

An open base condition can be obtained by setting the Type 576 step generator amplitude switch to .05 μ A.

Display Amplifiers

When the 176 is being used, the Type 576 display amplifiers operate normally, except that the X10 VERT button has been added to the 176 to add range to vertical measurements, and leakage measurements cannot be made. When the VERTICAL switch is set to one of its five highest deflection factors and the 176 X10 VERT button is pressed, the vertical deflection factor is increased 10 times. When the button is pressed, it lights and the increase in

deflection factor is indicated by the PER VERT DIV readout. When the VERTICAL switch is turned clockwise beyond its .1 A position, the X10 VERT button light goes out and the VERTICAL switch returns to normal operation. The X10 VERT button does not affect the positioning controls of the display amplifiers.

NOTE

When the VERTICAL DISPLAY FACTOR is not in the highest 5 display factors, the X10 VERT button will not change the vert display but will change the readout.

When the VERTICAL switch is set to STEP GEN and the X10 VERT button is pressed, a 50 amperes/division deflection factor is obtained. This deflection factor is not indicated on the PER VERT DIV readout and its accuracy is not specified.

Device Testing Jacks

Devices to be tested are connected to the 176 through the five Device Testing Jacks. These jacks allow one device to be tested at a time. Any of the Tektronix single-device test fixtures adapters can be plugged into these jacks. These adapters provide sockets into which devices with various lead arrangements may be placed for testing. Table 2-1 lists the test fixture adapters available for use with the 176 when this manual was prepared. (Others may now be available.) These jacks also accept standard banana plugs so that devices can be tested when it is inconvenient to use a particular device testing accessory, or when such an accessory is not available.

TABLE 2-1

Test Fixture Adapters Which May Be Used With the 176¹

Tektronix Part Number	Case Type
013-0072-00 ³	Diodes with axial leads (does not provide Kelvin sensing)
013-0100-00 ³	TO-3
013-0101-00 ³	TO-66
013-0110-00 ²	Diodes with stud leads; DO-4/DO-5
013-0111-00 ³	Diodes with axial leads (provides Kelvin sensing)
013-0112-00 ²	TO-36

¹This list contains only those test figure adapters available at the time this manual was being prepared. Additional adapters may now be available.

²Standard 176 accessory.

³Standard Type 576 accessory.

Operating Instructions—176

The jacks labeled C, B and E are the collector, base and emitter jacks, respectively. The jacks labeled C_{SENSE} and E_{SENSE} allow Kelvin sensing of voltages measured under high current conditions. Kelvin sensing means that current is supplied to a device under test through one set of contacts, and the voltage is measured through another set of contacts. This method of sensing voltage eliminates errors in voltage measurements due to contact resistance. C_{SENSE} and E_{SENSE} stand for collector sensing and emitter sensing, respectively.

EFFECTS OF 176 ON TYPE 576 CONTROLS

Since the 176 performs a specialized measurement function, some of the Type 576 controls, connectors and readout, do not perform the same functions as they would under normal operating conditions. The following table lists the Type 576 controls and their functions when the 176 is being used with the Type 576.

TABLE 2-2

**Change in Function of Type 576 Controls,
Connector and Readout When 176 is Used**

Control	Change in Function
READOUT ILLUM	None
GRATICULE ILLUM	None
INTENSITY	None
FOCUS	None
VERTICAL	Leakage measurements can not be made; 5 highest deflection factors can be multiplied by 10 by pressing 176 X10 VERT button; STEP GEN position provides 50 A/div deflection factor (with unspecified accuracy) when X10 VERT button is pressed.
DISPLAY OFFSET Selector	None
CENTERLINE VALUE	None
HORIZONTAL	None
POSITION (Vertical and Horizontal)	None
FINE POSITION (Vertical and Horizontal)	None

ZERO	None
CAL	None
DISPLAY INVERT	None
MAX PEAK VOLTS	1500 position is disabled.
MAX PEAK POWER WATTS	Disabled (MAX PEAK POWER WATTS buttons on 176 used instead).
VARIABLE COLLECTOR SUPPLY	None
POLARITY	AC position is not usable
MODE	May be set to NORM or DC (ANTI-LOOP). LEAKAGE (EMITTER CURRENT) position is not usable.
LOOPING COMPENSATION	Has no effect on display.
NUMBER OF STEPS	None
CURRENT LIMIT	None
AMPLITUDE STEPS/OFFSET	5 highest current step amplitudes can be multiplied by 10 by pressing 176 X10 STEP button.
OFFSET	When 176 X10 STEP button is lighted, offset is pulsed.
OFFSET MULT	When 176 X10 STEP button is lighted, the control becomes a 100 times multiplier.
STEPS	Not usable.
300 μ s and 80 μ s PULSED STEPS	None
STEP FAMILY	REP ON button is automatically pressed by plastic projection on 176 rear panel.
RATE	.5X button is automatically pressed by plastic projection on 176 rear panel.
POLARITY INVERT	None
.1X MULT	None
COLLECTOR SUPPLY VOLTAGE DISABLED Light	None

PER VERT DIV Readout	10 times multiplication is indicated when X10 VERT button is pressed.
PER HORIZ DIV Readout	None
PER STEP Readout	10 times multiplication is indicated when 176 X10 STEP button is pressed.
β OR g_m PER DIV Readout	None
CAMERA POWER Connector	None
Line Voltage Selector Assembly (Rear Panel)	None
50 Hz-60 Hz (Rear Panel)	None

FIRST TIME OPERATION

When the 176 is received, it is calibrated and should perform within the specification shown in Section 1. The following procedure allows the operator to become familiar with the 176 controls and their relationship to the Type 576. This procedure may also be used as a general check of the instrument's performance. For a check of the instrument's operation with respect to the specification given in Section 1, the performance check procedure in Section 5 must be used.

1. Install the 176 in the Type 576. Press the Type 576 300 μ s PULSED STEPS button.

2. Connect the Type 576 to a suitable power source and turn on the Type 576.

3. Allow the instruments to warm up for a few minutes. The instrument should operate within specified tolerances five minutes after the Type 576 has been turned on.

4. Set the 176 controls as follows:

MAX PEAK POWER-WATT	100
X10 VERT	Not illuminated
X10 STEP	Not illuminated
INTERLOCK OVERRIDE	Not pressed

5. Set the Type 576 controls as follows:

READOUT ILLUM	Visible Readout
GRATICULE ILLUM	Visible Graticule Line
INTENSITY	Visible Display
FOCUS	Centered
VERTICAL	50 mA
DISPLAY OFFSET	NORM (OFF)
Selector	
CENTERLINE VALUE	0
HORIZONTAL	5 V COLLECTOR
Vertical Position	Centered
Horizontal Position	Centered
DISPLAY INVERT	Released
MAX PEAK VOLTS	75
PEAK POWER WATTS	Has no effect
VARIABLE COLLECTOR	Fully Counterclockwise
POLARITY	+ (NPN)
MODE	NORM
LOOPING COMPENSATION	Has no effect
NUMBER OF STEPS	10
CURRENT LIMIT	20 mA
AMPLITUDE	0.5 μ A
OFFSET	ZERO
STEPS	Released
PULSED STEPS	300 μ S
POLARITY INVERT	Released
STEP MULT .1X	Released

6. Select an NPN power transistor with the following characteristics:

β	Between 20 and 50
I_c max	Greater than 10A
BV_{CEO}	75 V

Install the transistor in a suitable Test Fixture Adapter (TO-3, TO-36 or TO-66) and install the adapter in the Device Testing Jacks of the 176.

7. Put the protective box in place over the Test Fixture Adapter and close the lid.

8. Press the Type 576 ZERO button and adjust the spot to the intersection of the zero vertical and horizontal graticule lines of the CRT. Release the ZERO button.

9. Turn the Type 576 VARIABLE COLLECTOR SUPPLY control clockwise to obtain a collector-emitter voltage of 50 volts (10 divisions horizontally).

10. Set the Type 576 AMPLITUDE switch to 10 mA and adjust the VERTICAL switch for a display similar to

Operating Instructions—176

that shown in Fig. 2-2. (The VERTICAL switch should be set at one of its five highest current positions.)

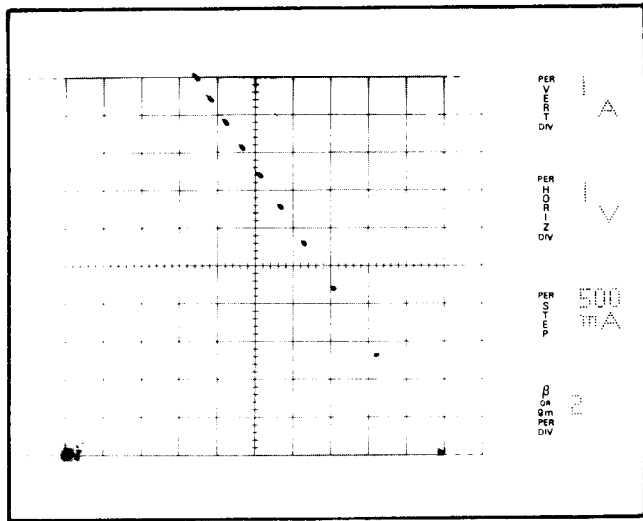

Fig. 2-2. Typical display of I_C vs V_{CE} for 10 different steps of base current for an NPN transistor.

11. Press the Type 576 OFFSET AID button and set the OFFSET MULT control for 2.00 (two steps of offset). Note that the zero step (or pulse) of the display is no longer on the zero horizontal graticule line. For normal pulsed base operation of the Type 576 (with the X10 STEP button not illuminated) the offset voltage or current is not pulsed.

12. Press the 176 X10 VERT button, which should illuminate the button. Note that the size of the vertical display is decreased by 10 times due to the 10X increase in the vertical deflection factor. The PER VERT DIV readout should also increase by 10 times.

13. Press the X10 STEP button, which should illuminate the button. Note that the size of the display increases due to the 10 times increase in the step generator step amplitude. The PER STEP readout should also increase by 10 times. Also note that the offset is now pulsed; thus, the pulses start from the zero horizontal line rather than from the offset level as discussed in step 11 for normal operation.

14. Lift the lid of the protective box. Note that the collector supply interlock opens and disables the collector

supply. This causes the red WARNING light on the 176 to go out, the yellow COLLECTOR SUPPLY VOLTAGE DISABLE light on the Type 576 to go on, and the display to disappear.

15. Leaving the lid of the protective box open, press the 176 INTERLOCK OVERRIDE button. This causes the collector supply to be enabled. Note that when the button is pushed, the yellow COLLECTOR SUPPLY VOLTAGE DISABLE light goes out, the red WARNING light goes on and a display re-appears.

WARNING

Pressing the INTERLOCK OVERRIDE button when the protective box is not in place enables the collector supply and makes operation of the instrument potentially dangerous. Operators should always be aware that when the red WARNING light is on, dangerous voltage may appear at the collector terminal.

16. Release the INTERLOCK OVERRIDE button and close the lid of the protective box.

17. Press the 1000 MAX PEAK POWER-WATTS button. Note that the maximum peak power being dissipated by the device under test (I_C versus V_{CE}) increases.

18. Press the 176 10 MAX PEAK POWER-WATTS button. Note that the maximum peak power decreases. Press the 100 MAX PEAK POWER-WATTS button.

19. Set the Type 576 AMPLITUDE switch to 5 mA. Note that the 176 X10 STEP button light goes out, and the step generator step amplitude is no longer multiplied by 10 times.

20. Set the Type 576 VERTICAL switch to 50 mA. Note that the 176 X10 VERT button light goes out, and the vertical deflection factor is no longer multiplied by 10 times.

This completes the first time operation procedure.

WARNING

THE FOLLOWING SERVICING INSTRUCTIONS ARE FOR USE BY QUALIFIED PERSONNEL ONLY. TO AVOID PERSONAL INJURY, DO NOT PERFORM ANY SERVICING OTHER THAN THAT CONTAINED IN OPERATING INSTRUCTIONS UNLESS YOU ARE QUALIFIED TO DO SO. REFER TO OPERATORS SAFETY SUMMARY AND SERVICE SAFETY SUMMARY PRIOR TO PERFORMING ANY SERVICE.



SECTION 3 MAINTENANCE

INDEX OF MAINTENANCE INFORMATION

The following table is a general index of the information found in section 3 through 8.

Adjustment Procedure (page 5-5)	The adjustment procedure describes the single internal adjustment in the 176.	Diagrams (section 7)	replacing relays; replacing push button bulbs; and soldering on circuit boards.
Block Diagram Description (page 4-1)	The block diagram description provides a functional description of the electrical operation of the 176. A functional block diagram is shown in Fig. 4-1 and an interconnection block diagram is provided at the beginning of the diagrams section.	Electrical Parts List (section 6)	A complete set of circuit diagrams is given in the fold-out pages in section 9. Also included in the diagrams section are an interconnection block diagram, circuit board pictures, and voltages and waveforms. Information regarding diagram symbols, voltage and waveform conditions, and assembly numbers can be found at the beginning of the diagram section.
Circuit Board Pictures (section 7)	Circuit board pictures accompany most diagrams in section 7. Each picture shows the locations of the circuit board-mounted components in the diagram. The pictures are located either on the apron of the fold-out diagram or on the back of the preceding diagram. The locations of Chassis-mounted components are not shown. Each circuit board is identified by an assembly number. Information regarding assembly numbers is discussed at the beginning of the diagrams section.	Mechanical Parts List and Mechanical Illustrations (section 8)	The electrical parts list is organized first by assembly number (with a separate list of chassis mounted components) and then by circuit number. Circuit number abbreviations and assembly numbers are discussed at the beginning of the diagrams section. Other abbreviations used in the electrical parts list along with electrical parts ordering information can be found at the beginning of the parts list.
Circuit Description (page 4-1)	The circuit description provides a detailed description of the electrical operation of the circuits of the 176. Simplified schematics are included.	Performance Check (page 5-1)	The mechanical parts list is arranged by mechanical parts illustration number and by the item numbers in each illustration. The mechanical illustrations are located on the backs of the last three diagrams in section 7.
Corrective Maintenance (page 3-3)	The corrective maintenance section provides information for: ordering electrical and mechanical components; tuning and replacing the coils of the charge lines; replacing semiconductors; removing and		The performance check procedure allows the operation of the 176 to be checked against the electrical characteristics given under performance requirements in section 1. It may be used both for incoming inspection and to provide periodic checks of the instrument operation.

Maintenance—176

Preventive Maintenance (page 3-1)	The preventive maintenance section provides information on cleaning, visual inspection and readjustment of the 176.
Troubleshooting (page 3-2)	The troubleshooting section lists equipment which will be helpful in troubleshooting the 176 as well as a general procedure for troubleshooting the 176.
Waveforms and Voltages (section 7)	Typical voltage measurements and waveform photographs are given on the diagrams in the diagrams section. The voltages are written on the circuit diagrams and the waveform pictures are normally found on the apron of each diagram. Voltages and waveform conditions are given at the beginning of the diagrams section.

is to be replaced, order new air filters from your local Tektronix Field Office or representative. The following procedure is suggested for cleaning the filter:

1. Remove one of the plastic side panels from the 176 and slide out the blue front panel. The filter may now be pulled out of the retaining frame in front of the fan.
2. Flush the loose dirt from the filter with a stream of hot water.
3. Wash the filter in soap and hot water.
4. Rinse the filter in clear water and allow it to dry.
5. Re-install the filter in the retaining frame, then replace the front panel and the side cover.

PREVENTIVE MAINTENANCE

General

Preventive maintenance consists of cleaning, visual inspection, etc. Preventive maintenance performed on a regular basis will improve the reliability of this instrument. The severity of the environment to which the 176 is subjected determines the frequency of the maintenance.

Cleaning

The best method of cleaning the exterior of the 176 is with a cloth dampened in a mild detergent and water solution. Abrasive cleaners should not be used. A small paint brush may also be useful for dislodging dirt on and around the front panel controls. The best method of cleaning the interior of the 176 is to blow out the accumulated dust with dry, low velocity air. Remove any dirt which remains with a soft paint brush or a cloth dampened with a mild soap and water solution. A cotton-tipped applicator is also useful for cleaning the narrow spaces on circuit boards.

CAUTION

Avoid the use of chemical cleaning agents which might damage the plastic used in this instrument. Avoid chemicals which contain benzene, toluene, xylene, acetone or similar solvents.

The air filter should be visually checked every few weeks and cleaned or replaced if dirty. More frequent inspections are required under severe operating conditions. If the filter

Visual Inspection

A brief visual inspection of the 176 should precede any performance check or readjustment. In making a visual inspection, look for broken connectors, loose pin connectors, heat damaged parts and damaged circuit boards.

Performance Check and Readjustment

To insure accurate operation, the performance of the 176 should be checked after each 1000 hours of operation or each six months, and, if necessary, readjusted. In addition, replacement of components may necessitate readjustment of the instrument. Complete performance check and adjustment instructions are provided in section 5.

TROUBLESHOOTING

Troubleshooting Equipment

1. Transistor Tester—some means of testing the semi-conductors used in the instrument is helpful. A transistor curve tracer such as the Tektronix Type 576 or Type 575 will give the most complete information.

2. DC Voltmeter and Ohmmeter—A 20,000 ohm/volt VOM can be used to check voltages and resistances. When checking voltages allowance must be made for circuit loading at high impedance points.

3. Test oscilloscope—A test oscilloscope is required to view waveforms at different points in the circuit. An oscilloscope with DC to 20 MHz frequency response and

100 mV/division to 10 V/division vertical deflection factors is suggested. A X10 probe should be used to reduce circuit loading.

4. 176 extension cables—4 extension cables are available from Tektronix which facilitate troubleshooting the 176. See item 4 in the section 5 equipment list for Tektronix part numbers.

General Troubleshooting Procedure

The following procedure is a general guide for troubleshooting the 176. It is arranged in an order which checks the simpler causes of malfunction first.

1. Check Control Settings. Check the control settings of both the 176 and the Type 576. Incorrect control settings can indicate a trouble which does not exist. If there is any question about the correct function or operation of any control, see the operating instructions in the 176 and Type 576 instruction manuals. It may also be helpful to run through the first time operation in section 2.

2. Check Performance of 176. The first time operation procedure provides a qualitative check of the 176 performance. To make a quantitative check of the 176 performance (check the operation of the 176 with respect to the electrical performance requirements given in section 1) use the performance check procedure provided in section 5 of this manual.

3. Check Performance of Type 576. If it is not clear whether a malfunction is being caused by the 176 or the Type 576, check the performance of the Type 576 independent of the 176. To make this check, substitute the Standard Test Fixture for the 176 in the Type 576. The first time operation procedure in section 2 of the Type 576 instruction manual provides a qualitative performance check of the Type 576 operation. The Performance Check/Calibration procedure in section 5 of the manual provides a quantitative check. If the malfunction is found to be part of the Type 576, check the Troubleshooting procedure in the maintenance section of the Type 576 manual.

4. Locate Malfunctioning Circuit in 176. The 176 is divided into two basic parts, the pulsed collector supply, and the base pulse amplifier. Each circuit is separated from the other, and therefore a malfunction should be easily localized. The block diagram description in section 4 should make clear any interactions in the circuitry.

5. Visual Check. Once the malfunction has been isolated to a particular section of the circuitry, visually check that part of the instrument. Many troubles can be located by

indications such as unsoldered connections, broken wires, damaged circuit boards, damaged components, etc.

6. Check Voltages and Waveforms. Often a defective component can be located by checking for the correct voltages and waveforms as given in blue in the circuit diagrams in the back of this manual. To obtain operating conditions similar to those used to take these readings, see the beginning of the diagrams section. Be sure to check the signals applied to the 176 from the Type 576.

7. Check Circuit Description. If checking the voltages and waveforms does not indicate the source of the malfunction, more detailed information about circuit operation may be necessary. The circuit description provides a circuit analysis of the circuit in the instrument. The emphasis in this section is on the operation of active components, and the signals and voltages which may be expected at various points within the circuits.

8. Check Individual Components. If the malfunction has not yet been located, check the individual components in the circuit. Components which are soldered in place are best checked after one end has been disconnected. This isolates the measurement from the effects of the surrounding circuit.

CORRECTIVE MAINTENANCE

Obtaining Replacement Parts

Standard Parts. All electrical and mechanical part replacements for the 176 can be obtained through your local Tektronix Field Office or representative. However, many of the standard electronic components can be obtained locally in less time than is required to order them from Tektronix, Inc. Before purchasing or ordering replacement parts, check the parts list for value, tolerance, rating and description.

NOTE

When selecting replacement parts, it is important to remember that the physical size and shape of a component may affect instrument performance. All replacement parts should be direct replacements unless it is known that a different component will not adversely affect instrument performance.

Special Parts. In addition to the standard electronic components, many special parts are used in the 176. These parts are manufactured or selected by Tektronix, Inc. to meet specific performance requirements, or are manufactured for Tektronix, Inc. in accordance with our specifications. Each

Maintenance—176

special part is indicated in the electrical parts list by an asterisk preceding the part number. Most of the mechanical parts used in this instrument have been manufactured by Tektronix, Inc. Order all special parts directly from your local Tektronix Field Office or representative.

Ordering Parts. When ordering replacement parts from Tektronix, Inc., include the following information.

1. Instrument Type
2. Instrument Serial Number
3. Circuit card series letter and model number (if part is mounted on a circuit card).
4. A description of the part (if electrical, include circuit number).
5. Tektronix part number.

Tuning the Charge Lines

There are five coils in each charge line (the 15 V charge line is actually one coil with four taps). The flatness of the 176 pulsed collector supply pulse tops is dependent on the spacing of these coils. The following procedure provides instructions for adjusting coil spacing for minimum ripple in the pulse tops.

1. Turn off the Type 576 and remove the 176. Unscrew and remove the 176 cabinet sides and cabinet top. Also unscrew the section of the chassis which has the device testing jacks attached to it. Replace the cabinet sides (not all the screws need to be replaced). Re-install the 176 in the Type 576. Connect a shorting strap between the collector and emitter jacks of the 176 device testing jacks. Install the protective box over the device testing jacks. Be sure the loose chassis section is not touching anything which may cause a short.

2. Obtain an oscilloscope with the following characteristics: vertical deflection factors of 20 V/div and 1 V/div using a 10X probe; vertical display offset of 20 V; 1 M Ω input impedance; sweep rate of 50 μ s/div; and triggering from line voltage. Tektronix 7504/7A13/7B50 or Tektronix Type 547/Type W are recommended.

3. Remove the side panel from the operators left of the Type 576. Connect the 10X probe to the upper deflection plate of the Type 576 CRT (white wire with blue stripe). The ground strap of the probe is not necessary. If used, connect it to the Type 576 chassis, not to the lower plate.

4. Turn on the Type 576 and oscilloscope and set the instrument controls as shown below. The Type 576 VERTI-

CAL and MAX PEAK VOLTS switches are set as shown in Table 3-1, depending on which charge line is to be adjusted. If all are to be adjusted, start with the 75 V charge line, then adjust the 350 V charge line, and finally the 15 V charge line.

Type 576

DISPLAY OFFSET Selector	NORM (OFF)
CENTERLINE VALUE	0
HORIZONTAL Vert and Horiz Position	200 V COLLECTOR Centered
VARIABLE COLLECTOR SUPPLY	Fully counterclockwise
POLARITY	+(NPN)
MODE	NORM
300 μ s PULSED STEPS	Pressed

176

MAX PEAK POWER-WATTS	1000
X10 VERT	Pressed
INTERLOCK OVER-RIDE	Not pressed

Test Oscilloscope

Vertical Deflection Factor	20 V/div
Horizontal Deflection Factor	50 μ s/div
Triggering	+Slope, Line

TABLE 3-1

TYPE 576 MAX PEAK VOLTS and VERTICAL Switch Settings When Tuning Charge Lines

Charge Line	MAX PEAK VOLTS	VERTICAL
15 Volt	15	2 A
75 Volt	75	.5 A
350 Volt	350	.1 A

5. Turn the Type 576 VARIABLE COLLECTOR SUPPLY control clockwise to obtain a pulsed collector supply pulse amplitude of 100 V (10 V with 10X probe). This should cause the spot on the Type 576 CRT to move vertically about 8 divisions.

6. Reduce the vertical deflection factor of the oscilloscope to 1 V/div. Position the pulse top to the center of the oscilloscope CRT with the oscilloscope vertical offset.

7. Compare the display of the pulse top with Figure 3-1. For each charge line, the outer coils control the outer peaks of the pulse top and the coils next to the center coil control the center of the pulse top. To adjust a coil, loosen the Allen screws securing the coil in place with an Allen wrench having an insulated shaft. Move the coils together or apart as necessary to equalize the peaks in the pulse top.

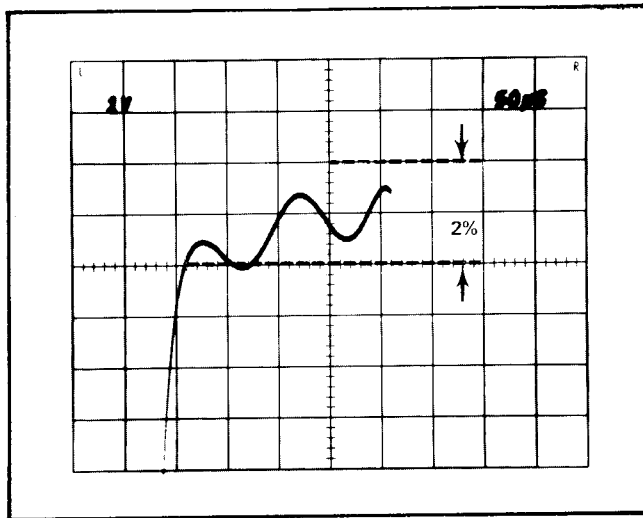

Fig. 3-1. Display of typical 176 Pulsed Collector Supply pulse top.

WARNING

Be particularly careful when adjusting the coils in the 75 V or 350 V charge lines. The voltages associated with these circuits make them potentially hazardous.

For a 100 V pulse, the maximum peak to peak ripple for the whole width of the pulse top should not be more than 2 V (2% of total pulse amplitude). A tool strong enough to pry the coils will probably be necessary to adjust the 15 V charge line coils.

8. When the coils have been adjusted for minimum pulse-top ripple, put the chassis section and cabinet top back in place over the 176. Do not replace the screws. Again, be careful not to short out anything with the chassis section.

9. Check the pulse top again. If the ripple has increased, remove the cabinet top and chassis section. Readjust the

coils to compensate for the change in inductance of the charge line when the chassis section and cabinet top are put in place.

10. Disconnect the oscilloscope from the Type 576. Set the Type 576 DISPLAY OFFSET Selector switch to VERT X10. Position the pulse top on the Type 576 CRT with the CENTERLINE VALUE switch. Check that the vertical width of the spot is no more than 2 divisions. If the spot looks like a slash, the front corner of the pulse is not rising fast enough. In this case, readjust the coil which controls the front corner of the pulse for a sharper front corner.

11. Reconnect the probe to the upper plate of the Type 576 CRT. Repeat parts 4 through 10 for the other coils which require adjustment.

12. Replace the chassis section and cabinet top and secure them in place with their screws.

Charge Line Coil Replacement

Use the following procedure to replace a coil or coils in a charge line.

1. Turn off the Type 576 and remove the 176 from the Type 576. Unscrew and remove the 176 cabinet sides and cabinet top. Also unscrew the part of the chassis which has the device-testing jacks attached to it.

2. Unsolder the wires attached to the coil to be removed.

3. Remove the Allen screws securing the coil in place. Remove the coil.

4. Place the new coil on the coil bracket in approximately the same location as the old coil. Secure it in place with the Allen screw.

5. Resolder the wires to the terminals on the new coil.

6. Retune the charge line containing the new coil, as described in the charge line tuning procedure.

Semiconductor Replacement

Fig. 3-2 shows the lead configurations of the semi-conductors used in this instrument.

Relay Removal and Replacement

Relays with Tektronix part numbers are not interchangeable. A diagram is given on the inside of the 176 cabinet bottom to indicate the part number of the relay which goes in each socket.

Pushbutton Bulb Replacement

The bulbs which light up the 176 pushbuttons are soldered to the PUSH SWITCH Circuit board. To replace one of these bulbs, remove the screws holding the circuit board in place.

Soldering on Circuit Boards

When soldering on a circuit board, use ordinary 60/40 solder and a 15 W pencil-type soldering iron. A higher wattage iron may separate the printed circuit alloy from the base material.

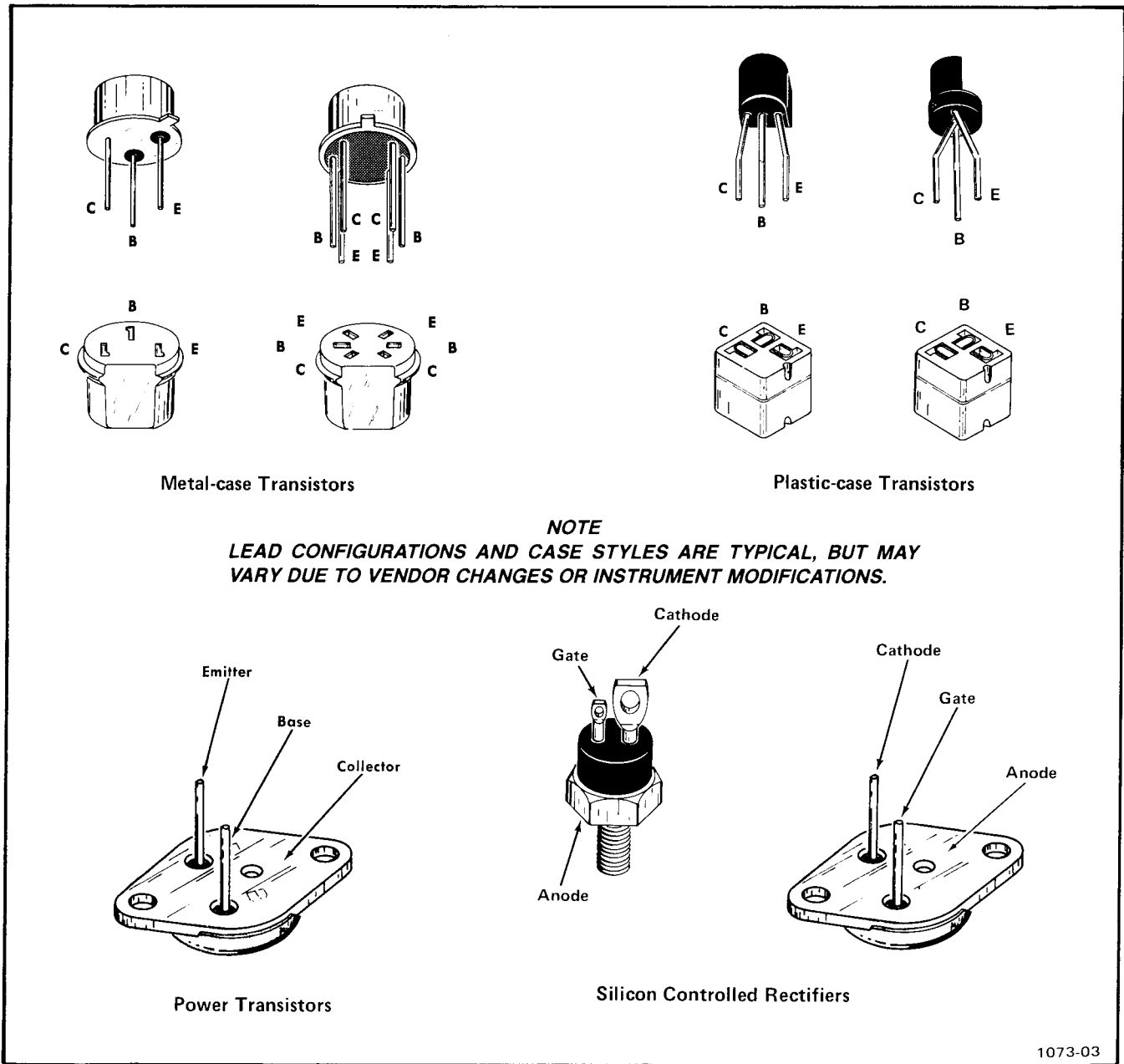

Fig. 3-2. Lead configurations of semiconductor devices used in the 176.

SECTION 4

CIRCUIT DESCRIPTION

BLOCK DIAGRAM DESCRIPTION

The 176 Pulse-High Current Fixture performs three major functions:

(1) It provides a high current, pulsed, collector supply output.

(2) It provides pulsed steps and offset (for the 5 highest current positions of the Type 576 AMPLITUDE switch) with amplitudes ten times greater than the switch settings.

(3) It increases the vertical deflection factor (for the 5 highest positions of the Type 576 VERTICAL switch) ten times.

The 176 base pulse amplifier receives pulsed steps from the Type 576 step amplifier of 1/2 volt per step through P361 pin 7 (see Fig. 4-1 and the Block Diagram at the beginning of the Diagrams Section). In addition, the 176 receives 300 μ s (or 80 μ s) wide pulses from the Type 576 step generator through P361 pin 8. The base pulse amplifier transforms these pulsed voltage steps and pulses into pulsed current steps with step amplitudes that are 10 times greater than the settings of the AMPLITUDE switch.

When the X10 STEP button is pressed, the pulsed steps are applied through K130 to the base terminal of the device under test. When the X10 STEP button is not pressed, or the AMPLITUDE switch is not in one of its five highest positions, normal pulsed steps from the Type 576 pulse generator are applied through K130 to the base of the device under test.

The pulsed collector supply circuit in the 176 produces the pulsed collector supply output. To obtain these pulses, the Type 576 Collector Supply charges a charge line in the pulsed collector supply circuit. The charge line is then discharged into the collector of the device under test during a 300 μ s (or 80 μ s) interval. The pulsed collector supply circuit is divided into three sections; the charge lines, the charge line trigger amplifiers, and the SCR current switches.

Each charge line is an open-ended delay line. It is charged by the collector supply during the positive half of the

collector supply cycle. During the negative half of the cycle, it is discharged into the collector of the device under test.

The charge line trigger amplifiers receive 300 μ s (or 80 μ s) pulses from the Type 576 step generator through P361 pin 8. When a charge line trigger amplifier is turned on, it amplifies these pulses and applies them to associated SCR current switches. When turned on by a charge line trigger amplifier, the SCR current switches provide current paths between a charge line and the collector terminal of the device under test. Since the charge line trigger amplifiers are triggered by the same pulses that trigger the base pulse amplifier, pulsed steps are applied to the base terminal of the device under test during the same interval that the charge line is discharged into the collector terminal.

The vertical deflection factor of the Type 576 is increased for the five highest positions of the VERTICAL switch by substituting new current setting resistors for the resistors normally used for those positions. When the 176 X10 VERT button is pressed, current setting resistor R385 conducts collector current from the device under test. The voltage across R385 is then applied to the external inputs to the Type 576 vertical display amplifier.

CIRCUIT DESCRIPTION

Base Pulse Amplifier

The base pulse amplifier produces current steps by applying voltage across a current setting resistor. The current conducted by the resistor is then applied to the device under test. The current step amplitude is determined by the size of the current setting resistor.

Differential amplifier Q208A and Q208B control the voltage across the current setting resistor, R265 (see Fig. 4-2). To obtain positive-going current steps, negative-going voltage steps are applied through R207 to the base of Q208A. These steps produce negative-going voltage steps at the collector of Q208B, which are applied to the base of Q260. When negative-going voltage steps are applied to the base of Q260. Positive-going voltage steps are developed at the collector of Q260, which pull up on the negative end of the floating power supply. The positive end of the floating

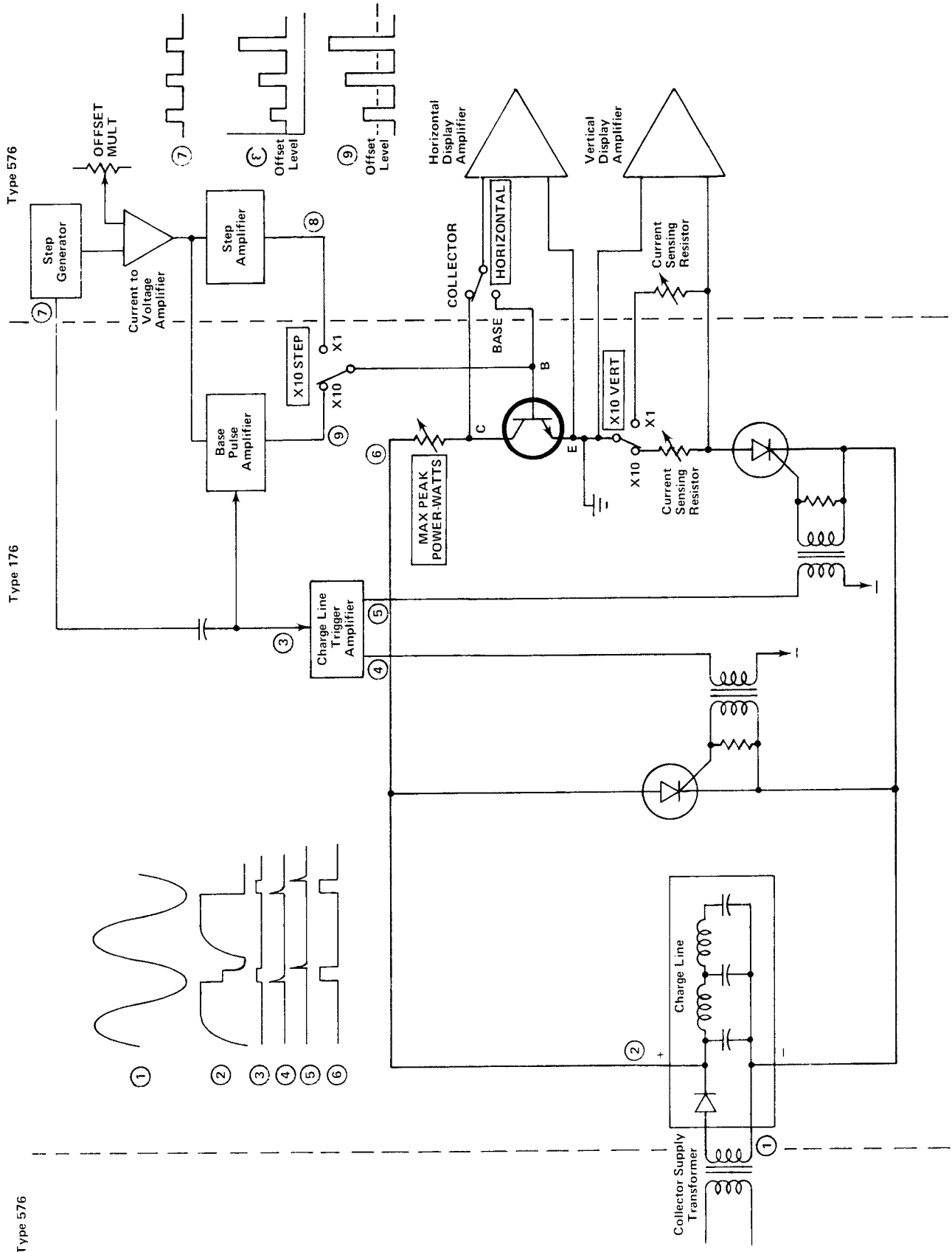

Fig. 4-1. Functional Block Diagram of 176.

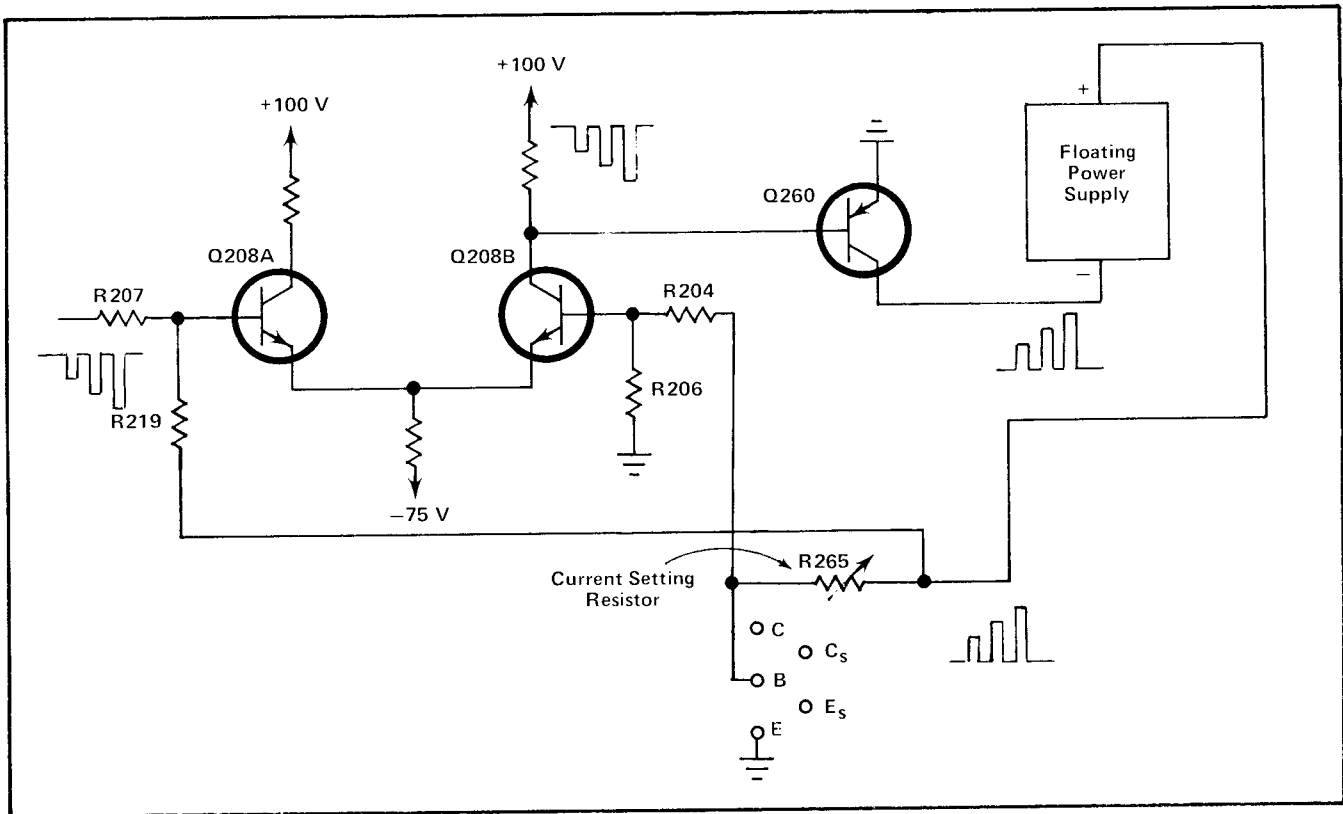

Fig. 4-2. Simplified schematic of base pulse amplifier circuit.

power supply is connected to one end of the current setting resistor. The other end of the current setting resistor is connected through R204 to the base of Q208B. Assuming zero load resistance, this end of the current setting resistor is held constant. Therefore, when the floating power supply is pulled up, a voltage is developed across the current setting resistor.

The voltage at the positive end of the floating power supply is fed back to the base of Q208A through R219. Input resistor R207 and feedback resistor R219 form an input to feedback ratio of 1:1. Thus when 1/2 volt steps are applied to the input of the differential amplifier, 1/2 volt steps are developed across the current setting resistor. When the base pulse amplifier circuit is loaded by a device under test, the voltage developed across this load is fed back to the base of Q208B through R204. The floating power supply is then raised accordingly to keep the step amplitude across the current setting resistor at 1/2 volt per step.

Looking at the actual circuit diagram of the base pulse amplifier (see the Base Pulse Amplifier diagram) it can be seen that the negative voltage steps applied to R207 are first transmitted through emitter follower Q202A. The negative-going steps produced at the collector of Q202A are applied to the base of Q260 through emitter follower Q218. The collector of Q260 is connected to two emitter

followers in series to allow the floating power supply to conduct more current. The device-under-test end of the current setting resistor is connected to the base of Q208B through Q202B. R212 (ZERO ADJUST) sets the base voltage of Q208B. R212 is adjusted so that the voltage across the current setting resistor is zero when neither steps nor offset are applied to Q208A. The size of the current setting resistor is determined by relays K240, K250 and K260.

To obtain negative-going current steps, positive-going steps are applied to the base of Q202A, which cause positive-going steps to appear on the emitter of Q218. In this case, K270 is activated, and the negative end of the floating power supply is connected to the current setting resistor rather than to Q260, Q264 and Q268. The positive end of the supply is connected to Q250, Q254 and Q258 rather than to the current setting resistor. When positive-going steps are applied to the base of Q250, the floating power supply is forced negative, developing a negative voltage across the current setting resistor. This negative voltage causes the base of the device under test to conduct negative current.

CR258 and CR268 provide protection for Q250, Q254 and Q258, and Q260, Q264 and Q268, respectively, if the base terminal of the device under test is accidentally

Circuit Description—176

shorted to the collector supply. VR275 provides similar protection for the floating power supply.

Q230 and Q236 control the pulsing of the base pulse amplifier circuit. When no pulses are applied to Q230, it is off and Q236 is on. With Q236 on, the bases of Q250 and Q260 are clamped to zero volts. When a positive-going pulse (300 μ s or 80 μ s wide) is applied to the base of Q230 from the Type 576 step generator, Q230 turns on. With Q230 on, Q236 is off and CR236 is reverse biased. The base pulse amplifier circuit now furnishes current to the base of the device under test. When the pulse ends, Q230 turns off, Q236 turns on, and the base pulse amplifier is again disabled.

The X10 STEP button, S130, controls relay K130 (see the Mode Switching diagram). K130, Q130 and Q132 operate as a self-latching circuit. When the X10 STEP button is pressed, Q130 turns on, K130 is energized and Q132 turns on. When the X10 STEP button is released, K130 stays energized until Q130 or Q132 turn off. Q130 (controlled by pins 12, 15 and 16 of P361) turns off whenever the Type 576 AMPLITUDE switch is set to a position below its five highest current positions. Q132 turns off only if pin 9 of P362 is grounded.

Pulsed Collector Supply

General. The unrectified collector supply voltage from the Type 576 is applied to the 176. In the 176, CR325 (see Fig. 4-3) half wave rectifies this input voltage and applies the rectified voltage to the charge line. The charge line is thus charged during the positive half cycle of the Type 576 Collector Supply output, and disconnected from the supply during the negative half cycle. The charge line is discharged into the device under test during the negative half cycle.

When the Type 576 collector supply voltage is at its negative peak, a 300 μ s (or 80 μ s) wide pulse is applied to the charge line trigger amplifier at the base of Q336. This positive-going pulse turns on Q336 and Q356, and turns off Q352. Q356 controls the gate of either SCR current switch Q358, or Q360, depending on the state of K320-S2. (K320 is controlled by the Type 576 POLARITY switch.) Q352 controls the gate of Q354.

Assume the POLARITY switch is set to + (NPN), de-energizing K320. In this case, K320-S2 connects the collector of Q356 to T360 (through R361-C361, and K320-S4 connects the + side of the charge line to the current limiting resistor.

When Q356 is turned on, the pulse at its collector is inverted by T360. The inverted pulse turns on Q360. With Q360 on, current is conducted from the + side of the

charge line, through the current limiting resistor, and into the device under test. After the current passes through the device under test, it is conducted through the current sensing resistor, through Q360, and into the - side of the charge line.

At the end of the 300 μ s (or 80 μ s) pulse, Q336 turns off, which turns off Q356 and turns on Q352. The negative-going pulse from the collector of Q352 is inverted by T354, and the resulting positive-going pulse turns Q354 on. Q354 then discharges the charge line, bypassing the device under test. When the current conducted by Q354 and Q360 falls below their minimum holding current levels, the SCR's turn off and the circuit is ready to begin another cycle.

When the POLARITY switch is set to - (PNP), K320 is energized. Now, K320-S2 connects the collector of Q356 to T358, and K320-S4 connects the - side of the charge line to the current limiting resistor. When Q356 turns on, T358 turns on Q358. Current is now conducted from the + side of the charge line, through Q358, through the current sensing resistor and into the - side of the device under test. Negative current is thus conducted through the device under test. Current returns to the - side of the charge line through the current limiting resistor.

R351 provides additional current for SCR's Q358 and Q360 which allows them to remain on when triggered, even though less than the minimum holding current is being conducted by the device under test. This ensures an output pulse-width of 300 μ s (or 80 μ s).

Charge Lines. There are three charge lines in the 176, one each for the 15 volt, 75 volt and 350 volt ranges of the pulsed collector supply (see the Charge Line diagram). Each charge line is made up of coils and capacitors, and is essentially an open-ended delay line.

The Type 576 collector supply is applied to the 176 through P362 pins 8, 15 and 16 (see the Pulse Collector Supply diagram). In the 176, CR325 (for the 15 volt or 75 volt ranges), or CR321, CR323 and CR325 (for the 350 volt range) half-wave rectifies the input voltage from the collector supply. This rectified voltage is then applied to the charge line associated with the voltage range chosen by the Type 576 MAX PEAK VOLTS switch, through K340-S1 for the 15 volt range, K330-S1 for the 75 volt range and K310-S1 and S3 for the 350 volt range.

Current is returned from the charge line to the Type 576 collector supply is through one of two paths, depending on the voltage range. For the 15 volt or 75 volt ranges, the return path is through K340-S2 or K330-S2, respectively,

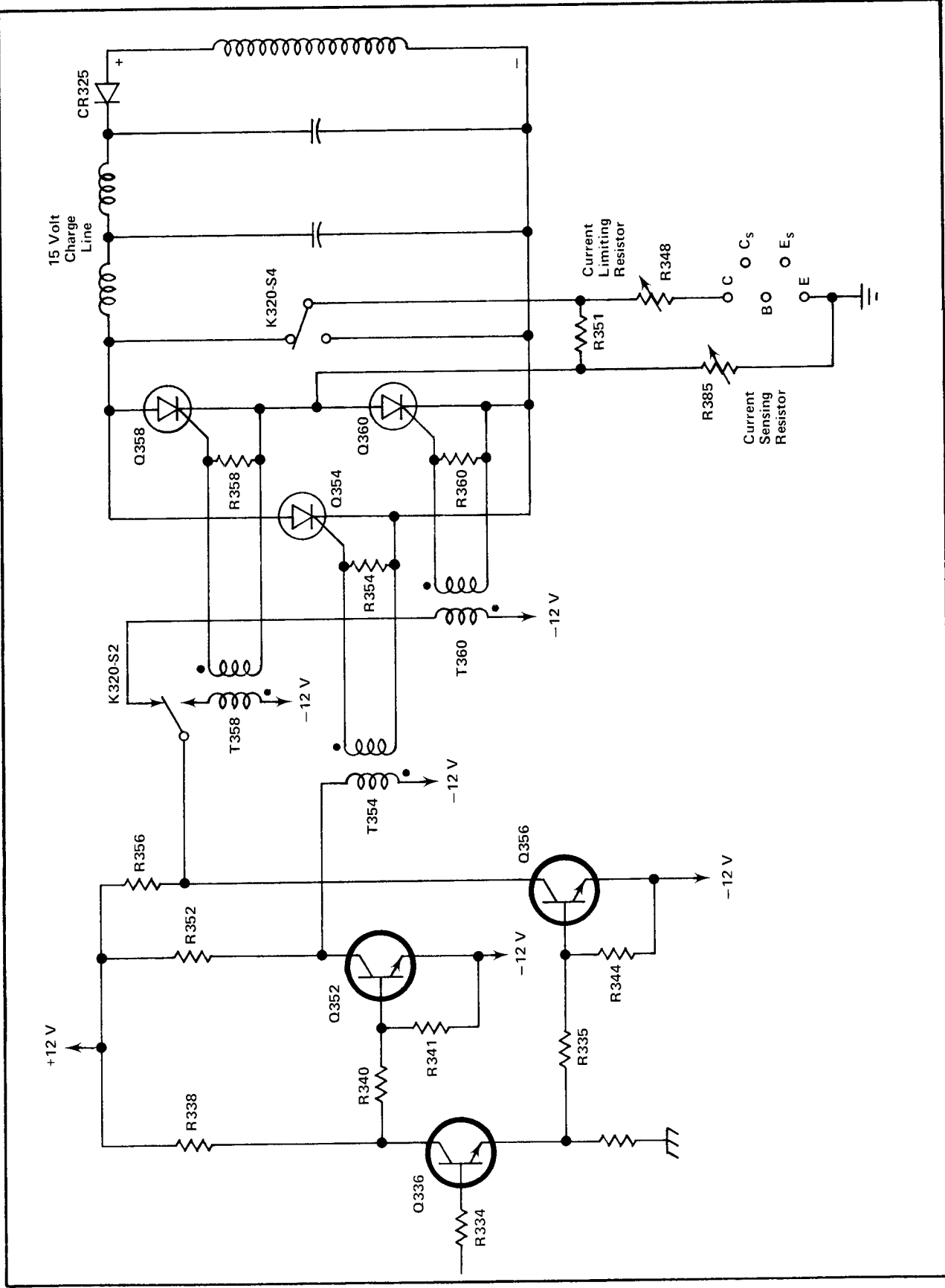

Fig. 4-3. Simplified schematic of Pulsed Collector Supply circuit.

Circuit Description—176

and then through P360 pins 13, 28 and 29. In the 350 volt range, the return path is through K310-S2 and then through P362 pin 7.

The number of capacitors in the 15 V charge line and their values are determined in the factory. They vary between instruments. They are selected to provide the best pulse shape for the collector supply pulses in the 15 V range.

Charge Line Trigger Amplifiers. There are two identical charge line trigger amplifiers in the 176, one for the 75 volt and 350 volt charge lines and one for the 15 volt charge line. K340-S3 determines which circuit is used.

When the Type 576 MAX PEAK VOLTS switch is set to 15, K340 is energized and the 15 volt charge line trigger amplifier is connected to the +12 volt supply. The 300 μ s (or 80 μ s) pulses are applied to both charge line trigger amplifiers through Q302. When the 15 volt circuit is being used, the pulse turns on Q336. The 15 volt charge line trigger amplifier operates as described in the general description of the pulsed collector supply, with the addition of emitter followers Q342 and Q346.

When the Type 576 MAX PEAK VOLTS switch is set to either 75 or 350, K340 remains de-energized, so the 75 volt and 350 volt charge line trigger amplifier is connected to the +12 volt supply. In this case the 300 μ s (or 80 μ s) pulses turn on Q306.

SCR Current Switches. There are also two identical SCR current switching circuits, one for the 15 volt charge line and one for the 75 volt and 350 volt charge lines. Both circuits operate as described in the general description of the pulsed collector supply. Relay K320 determines the polarity of the pulsed collector supply. It is controlled by the Type 576 POLARITY switch, through P362 pin 2. When the switch is set to – (PNP), this line is grounded which energizes K320.

Current Limiting. R321, R327 and R348 provides current limiting for the pulsed collector supply. (The collector supply voltage applied to the 176 bypasses the current limiting resistors in the Type 576 Collector Supply.) The resistor used for current limiting depends on the collector supply range chosen by the Type 576 MAX PEAK VOLTS switch. For the 15 volt range, K340-S4 is closed and R348 limits current; for the 75 volt range, K330-S3 is closed and R321 limits current; and for the 350 volt range, K310-S4 is closed and R327 limits current.

For all three pulse collector supply ranges, the current limiting resistor is bypassed when the 1000 MAX PEAK POWER-WATTS button is pressed. The resistor is center tapped when the 100 button is pressed, and the whole resistor is used when the 10 button is pressed. Relays K110, K120, K310 and K355 determine which part of the resistor is used.

K110 and K120 are controlled by the MAX PEAK POWER-WATTS buttons (see the Mode Switching diagram). Both relays are self latching. When the 1000 button is pressed, K110 is energized and Q110 is turned on. With Q110 conducting, K110 remains energized after the 1000 button is released. Q110 continues to conduct until turned off by the selection of another power range. When Q110 is on, it clamps the base of Q120 to ground through CR125 and keeps K120 de-energized. The conduction of Q110 also causes Q104 to conduct which keeps Q106 and DS106 turned off. The 100 button circuit operates the same as the 1000 button circuit. In this case, K120 is energized, turning on Q120 and turning Q110 off.

When the 10 button is pressed, Q110 and Q120 are turned off de-energizing K110 and K120. Q104 is now turned off, so Q106 begins conducting, turning on DS106. DS106 and Q106 will remain on when the 10 button is released. K110 and K120 can also be remotely controlled through pins 9, 10 and 11 of P362.

When the 1000 button is pressed and the Type 576 MAX PEAK VOLTS switch is set to 15, K350 and K355 provides current paths between the – and + sides, respectively, of the charge line and the collector jack of the device testing jacks (see the Pulsed Collector Supply diagram). In this case, the coils of both K350 and K355 are connected to the +12 volt supply through K110-S2 and K340-S3. When the Type 576 POLARITY switch is set to + (NPN), pin 2 of P362 is open. Q350 is conducting, which energizes K355. K350 is de-energized. With K355 energized, the + side of the charge line is connected through K355 directly to the collector jack. When the POLARITY switch is set to – (PNP), pin 2 of P362 is held at ground, which energizes K350 and de-energizes K355. In this case, the – side of the charge line is connected through K350 to the collector jack.

Interlock. The operation of the 176 interlock system is identical to that of the Type 576, with the exception of the INTERLOCK OVERRIDE button, S162. When the yellow Type 576 COLLECTOR SUPPLY VOLTAGE DISABLE light is on, it indicates that the voltage input to the collector supply transformer has been disconnected. In this case, the collector supply can be enabled either by installing the protective box of the 176 and closing its lid, which closes S160, or by pressing the INTERLOCK OVERRIDE button, which closes S162. When either of these switches is closed, the collector supply is enabled and the red WARNING light is on.

WARNING

When the red WARNING light is on, potentially dangerous voltage may appear at the collector jack of the device testing jacks.

Vertical Sensitivity

The Type 576 vertical display amplifier senses current either through the current sensing resistors in the Type 576 or through R385 in the 176 (see the Pulsed Collector Supply diagram). The X10 VERT button on the 176 determines which method of current sensing is used.

When the X10 VERT button has not been pressed, current from the emitter jack of the 176 device testing jacks is conducted through P360 pins 9, 10 and 16 to the current sensing resistors in the Type 576. The current is then returned to the 176 through P360 pins 11, 12 and 27.

When the X10 VERT button is pressed, K150 is energized which opens the current return path from P360 pins 11, 12 and 27 through K150-S3. Current from the

emitter jack is now conducted through R385 and back to the charge line through K380 or K390. External inputs to the Type 576 vertical display amplifier are connected across R385 through P363 pins 11 and 12. K380 and K390 are controlled by Q380 and Q390. These transistors are controlled by the Type 576 VERTICAL switch.

The X10 VERT button, S150, controls relay K150 (see the Mode Switching diagram). K150, Q150 and Q152 operate as a self-latching circuit. The circuit is identical to the X10 STEPS button self-latching circuit. When the X10 VERT button is pressed and has been released, K150 will stay energized until Q150 or Q152 has been turned off. Q150 (controlled by pins 2 and 3 of P363) is turned off whenever the Type 576 VERTICAL switch is set below its five highest positions. Q150 can only be turned off if pin 9 of P362 is grounded.

SECTION 5

PERFORMANCE CHECK AND ADJUST

GENERAL

Introduction

This section contains two procedures: a performance check procedure and an adjust procedure. The performance check procedure provides instructions for checking the performance of the 176 with respect to the electrical performance requirements given in the center column of the Section 1 Specification. The adjust procedure provides instructions for making the single internal adjustment in the 176.

The 176 should be checked and, if necessary, readjusted after each 1000 hours of operation, or at least once every six months, to insure that it is operating properly. In addition, the instrument may require readjustment if components have been replaced or other electrical repairs have been made.

NOTE

The Type 576 must be calibrated and its performance checked before the 176 can be accurately checked or adjusted. Refer to Section 5 of the Type 576 instruction manual.

Maintenance

Any maintenance required on the 176 should be completed before starting this procedure. If troubles occur in the middle of the procedure, they should be corrected before proceeding. Repair and servicing information is given in the Maintenance section of this manual.

Equipment List

The following list gives the equipment required for both procedures:

1. Type 576 Curve Tracer.
2. 176 Standard Load Resistor (Tektronix Part Number 067-0632-00). A circuit diagram for this fixture including its resistor values and tolerances is given in Fig. 5-1.

3. Four-inch shorting strap with standard banana plug connectors.

4. (Adjust only) Four extension cables: two 16 pin cables (Tektronix Part No. 012-0038-01; one 24 pin cable (Tektronix Part No. 012-0269-00); and one 32 pin cable (Tektronix Part No. 012-0268-00). These four cables are available in a kit (Tektronix Part No. 067-0633-00).

5. (Adjust only) Non-conducting screwdriver adjustment tool.

Record and Index

Table 5-1 at the beginning of the performance check procedure provides a record and index of the procedure. The table may be used as a check list to verify correct performance; an abridged guide for a technician familiar with the 176 performance check procedure; or an index of individual checks.

Control Setting

A complete list of initial control settings for the 176 and significant control settings for the Type 576 precede each procedure.

PERFORMANCE CHECK PROCEDURE

1. Install the 176 in the Type 576. Press the Type 576 300 μ s PULSED STEPS button.

2. Set the Line Voltage Selector assembly and the 50 Hz-60 Hz switch on the Type 576 rear panel for the line voltage and frequency to be used to operate the Type 576/176.

3. Connect the Type 576 to the power source.

4. Turn on the Type 576

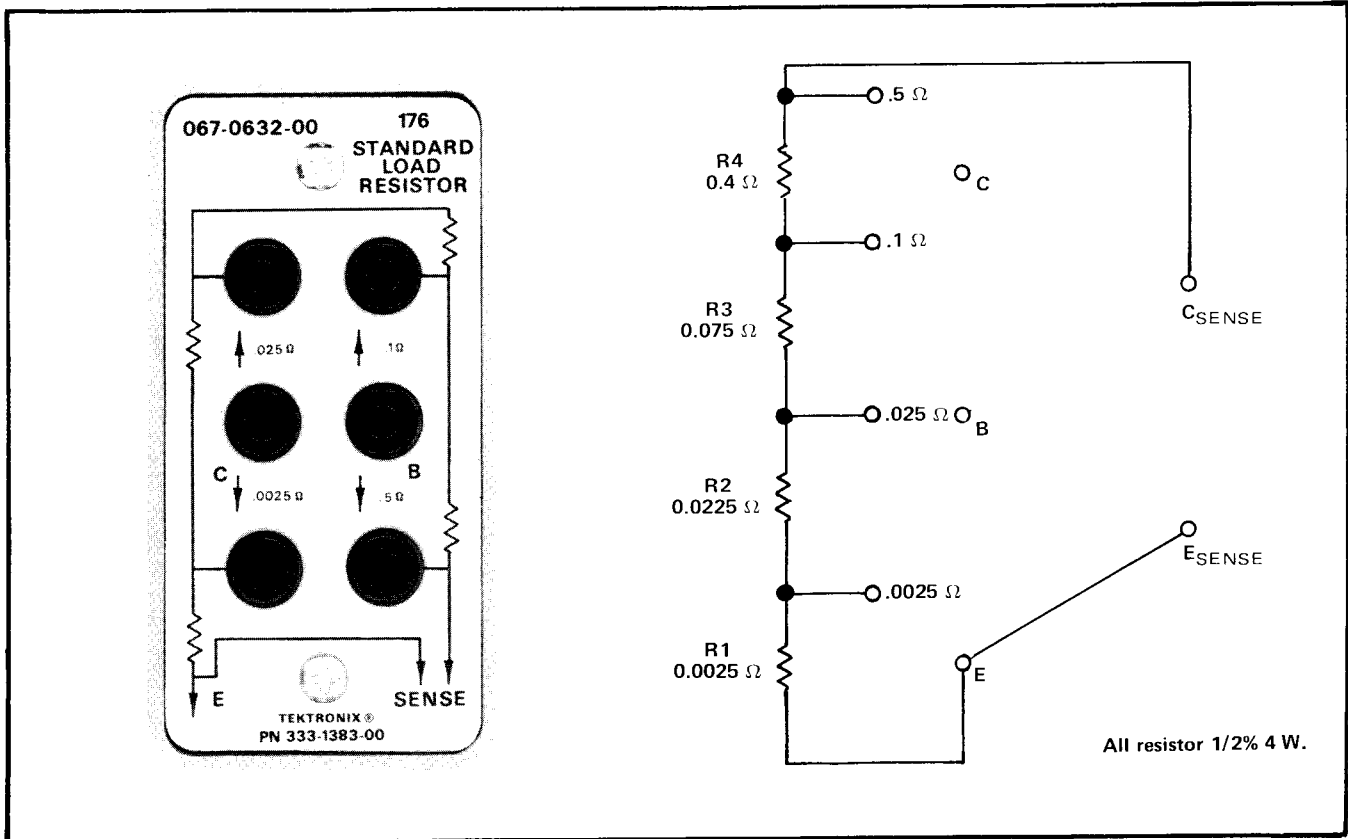

Fig. 5-1. 176 Standard Load Resistor.

TABLE 5-1
Performance Check Procedure
Index and Record

Step No.	Title	Page
1	Check Vertical Display Accuracy	5-2
2	Check Step Generator Accuracy with X10 STEP Button Illuminated	5-3
3	Check Maximum Step Generator Output with X10 STEP Button Illuminated	5-4
4	Check Maximum Open Circuit Voltage and Minimum Short Circuit Current of Collector Supply	5-4

Type 576

VERTICAL	.2 A
DISPLAY OFFSET Selector	VERT X10
CENTERLINE VALUES	10
HORIZONTAL	.05 V COLLECTOR
Vertical Positioning	Centered
Horizontal Positioning	Centered
MAX PEAK VOLTS	15
VARIABLE COLLECTOR SUPPLY	Fully Counterclockwise
POLARITY	+(NPN)
MODE	NORM
NUMBER OF STEPS	10
CURRENT LIMIT	2 A
AMPLITUDE	20 mA
OFFSET	ZERO
OFFSET MULT	0.000
300 μs PULSED STEPS	Pressed
POLARITY INVERT	Released
STEP MULT .1X	Released

Initial Control Settings

176

MAX PEAK POWER-WATTS	1000
X10 VERT	Illuminated (Type 576 VERTICAL switch must be set to .2A)
X10 STEP	Not Illuminated

1. Check Vertical Display Accuracy

a. Set the 176 and Type 576 controls as shown in the list of initial control settings preceding this step.

b. Install the 176 Standard Load Resistor in the 176 device testing jacks and plug the shorting bar over the .025 Ω label.

c. Press the Type 576 ZERO button and position the spot to the intersection of the zero vertical and center horizontal graticule lines. Release the ZERO button.

d. Turn the Type 576 VARIABLE COLLECTOR SUPPLY control clockwise until the spot intersects with the tenth vertical graticule line. (The spot will probably be elongated.) Position the middle of the spot on the tenth vertical graticule line.

e. CHECK FOR—Middle of spot intersecting with the center horizontal line ± 2 divisions (within 2% of highest on-screen value).

f. Turn the VARIABLE COLLECTOR SUPPLY control fully counterclockwise and set the VERTICAL switch to 2 A. Plug the shorting bar across the .0025 Ω label on the standard load resistor. Repeat parts d and e.

g. CHECK FOR—Vertical width of the brightest part of the spot less than 2 divisions (pulse flatness less than 2% of peak collector supply voltage). (If vertical pulse width is not within 2 divisions, see the note at the end of the adjust procedure.)

h. Repeat parts d and e.

2. Check Step Generator Accuracy with X10 STEP Button Illuminated

a. Reset the following Type 576 controls:

DISPLAY OFFSET Selector	HORIZ X 10
CENTERLINE VALUE	1
VARIABLE COLLECTOR SUPPLY	Fully Counterclockwise

b. Press the 176 X10 STEP button.

c. Connect the shorting bar across the .5 Ω label on the 176 Standard Load Resistor.

d. Press the ZERO button and position the spot to the center vertical graticule line. Release the ZERO button.

e. CHECK FOR—Spot on the center vertical graticule line ± 0.6 division (3% of 0.2 A x 0.5 Ω).

f. Press the Type 576 AID OFFSET button and slowly turn the OFFSET MULT control 1/4 turn clockwise.

g. Check that the spot begins moving to the operators right as soon as the OFFSET MULT control is turned. If there is a lag between the turning of the OFFSET MULT control and the movement of the spot, or if the spot is out of tolerance in part e, R212 needs adjusting.

h. Reset the following Type 576 controls:

HORIZONTAL OFFSET	.1 V COLLECTOR ZERO
OFFSET MULT	0.00

i. Note the horizontal position of the spot (step), then turn the CENTERLINE VALUE switch two positions counterclockwise.

j. CHECK FOR—Horizontal position of the next spot within 0.5 division (5% of 200 mA X 0.5 Ω) of spot position noted in part i.

k. Repeat parts i and j for the whole range of the CENTER LINE VALUE switch.

l. Reset the following Type 576 controls:

CENTERLINE VALUE	0
AMPLITUDE	200 mA
.1 X STEP MULT	Pressed

m. Note the horizontal position of the spot and turn the CENTER LINE VALUE switch counterclockwise two positions.

n. CHECK FOR—Horizontal position of next spot within 1 division (10% of 200 mA X 0.5 Ω) of spot position noted in part m.

o. Repeat parts m and n for the whole range of the CENTER LINE VALUE switch.

p. Reset the following Type 576 controls:

HORIZONTAL .1X STEP MULT	.2 V COLLECTOR Released
CENTERLINE VALUE	10

q. Connect the shorting bar across the .1 Ω label of the 176 Standard Load Resistor.

Performance Check and Adjust—176

r. Press the ZERO button and position the spot on the center horizontal graticule line. Release the ZERO button.

s. CHECK FOR—Spot on center horizontal line ± 3 divisions (3% of total output).

t. Set the HORIZONTAL switch, the AMPLITUDE switch and the 176 Standard Load Resistor shorting bar as shown in Table 5-2. For each setting of the AMPLITUDE switch, repeat part s.

TABLE 5-2

Check Step Generator Accuracy

Type 576		176 Standard Load Resistor
HORIZONTAL	AMPLITUDE	
.2 V COLLECTOR	200 mA	.1 Ω
.1 V COLLECTOR	100 mA	.1 Ω
.05 V COLLECTOR	50 mA	.1 Ω
.1 V COLLECTOR	20 mA	.5 Ω
.05 V COLLECTOR	10 mA	.5 Ω

3. Check Maximum Step Generator Output with X10 STEP Button Illuminated

a. Reset the following Type 576 controls:

DISPLAY OFFSET Selector NORM (OFF)
 OFFSET AID
 OFFSET MULT Fully Clockwise

b. Set the HORIZONTAL switch, the AMPLITUDE switch and the 176 Standard Load Resistor shorting bar as shown in Table 5-3.

TABLE 5-3

Check Maximum Step Generator Output

Type 576		176 Standard Load Resistor
HORIZONTAL	AMPLITUDE	
.1 V COLLECTOR	10 mA	.5 Ω
.2 V COLLECTOR	20 mA	.5 Ω
.1 V COLLECTOR	50 mA	.1 Ω
.2 V COLLECTOR	100 mA	.1 Ω
.5 V COLLECTOR	200 mA	.1 Ω

c. CHECK FOR—Eleventh spot (step) on tenth vertical graticule line for the 10 mA, 20 mA, and 50 mA of the AMPLITUDE switch. For the 100 mA position, the ninth spot

should be on the ninth vertical graticule line. For the 200 mA position, the spot should be to the operator's right of the fourth vertical line.

d. Set the HORIZONTAL switch to 1 V COLLECTOR.

e. CHECK FOR—Display to right of second vertical graticule line. The display will be several spots along a line.

f. Set the AMPLITUDE switch to 100 mA and connect the shorting bar across the .5 Ω label of the 176 Standard Load Resistor.

g. CHECK FOR—Display to right of center vertical graticule line.

4. Check Maximum Open Circuit Voltage and Minimum Short Circuit Current of Collector Supply

a. Set the 176 and Type 576 controls as indicated in the initial list of control settings at the beginning of this procedure, except for the following changes:

Type 576

VERTICAL 2A
 DISPLAY OFFSET Selector NORM (OFF)
 CENTERLINE VALUE 0
 HORIZONTAL 2 V COLLECTOR
 AMPLITUDE .05 μ A

b. Remove the 176 Standard Load Resistor from the 176.

c. Press the ZERO button and position the spot to the intersection of the zero vertical and horizontal graticule lines.

d. Set the MAX PEAK VOLTS switch and the HORIZONTAL switch as shown in Table 5-4. For each setting of the MAX PEAK VOLTS switch, turn the VARIABLE COLLECTOR SUPPLY control fully clockwise.

e. CHECK FOR—Spot displaced from zero vertical graticule line shown in Table 5-4 under peak voltage for each position of the MAX PEAK VOLTS switch. (The INTERLOCK OVERRIDE button must be pressed when the yellow Type 576 COLLECTOR SUPPLY VOLTAGE DISABLED light is on.)

TABLE 5-4
Check Peak Collector Supply Voltage

Type 576		Peak Voltage
MAX PEAK VOLTS	HORIZONTAL	
15	2 V COLLECTOR	7.5 div, -0.9 div +1.4 div
75	10 V COLLECTOR	7.5 div, -0.4 div +2.6 div
350	50 V COLLECTOR	7 div, -0.4 div +2.5 div

WARNING

When the red WARNING light is on, dangerous voltages may appear at the device testing jacks.

f. Turn the VARIABLE COLLECTOR SUPPLY control fully counterclockwise and connect a shorting strap between the collector jack and the emitter jack of the device testing jacks.

g. Set the MAX PEAK VOLTS switch and the VERTICAL switch as shown in Table 5-5. For each setting of the MAX PEAK VOLTS switch, turn the VARIABLE COLLECTOR SUPPLY control fully clockwise.

h. CHECK FOR—Spot displaced from zero horizontal graticule line at least as many divisions as shown in Table 5-5 under Minimum Peak Current, for each position of the MAX PEAK VOLTS switch.

TABLE 5-5
Check Minimum Peak Collector Supply Current

Type 576		Minimum Peak Current
MAX PEAK VOLTS	VERTICAL	
15	2 A	10 div
75	1 A	4 div
350	2 A	4 div

ADJUST PROCEDURE

1. Remove the Standard Test Fixture from the Type 576.

2. Connect the 176 to the Type 576 using the four extension cables described in the equipment list.

3. Set the Line Voltage Selector assembly and the 50 Hz-60 Hz switch on the Type 576 rear panel for the line voltage and frequency to be used to operate the Type 576/176.

4. Turn the 176 on its side and remove the bottom panel from the 176.

WARNING

Removal of the 176 bottom panel exposes the operator to potentially hazardous voltages.

5. Connect the Type 576 to the power source.

6. Turn on the Type 576. Allow the instruments to warm up for about 5 minutes at an ambient temperature of 25°C ±5°C.

Control Settings

176

MAX PEAK POWER-WATTS 1000
X10 VERT Illuminated
X10 STEP Illuminated

Type 576

VERTICAL 2A
DISPLAY OFFSET Selector HORIZ X10
CENTERLINE VALUE 0
HORIZONTAL .05 V COLLECTOR
Vertical Positioning Centered
Horizontal Positioning Centered
MAX PEAK VOLTS 15
VARIABLE COLLECTOR Fully Counterclockwise
Supply
POLARITY +(NPN)
MODE NORM
AMPLITUDE 20 mA

1. Adjust R212 (ZERO ADJUST)

a. Set the 176 and Type 576 controls as shown in the preceding list of control settings.

b. Install the 176 Standard Load Resistor in the device testing jacks of the 176 and connect the shorting bar across the .5 Ω label.

c. Press the Type 576 ZERO button and position the spots to the center vertical graticule line of the Type 576 CRT. Release the ZERO button.

Performance Check and Adjust—176

d. Turn R212 (ZERO ADJUST) on the bottom side of the instrument (see Fig. 5-2) throughout its range. Note that the spot moves to the operator right of the center vertical graticule line, but not to the left of center. Set R212 so that the spot is to the right of the centerline. Now turn R212 in the opposite direction until the spot is just on the center vertical graticule line.

e. Set the Type 576 POLARITY switch to -(PNP) and check that the spot is horizontally centered

f. Turn R212 in the opposite direction that it was turned at the end of part d. Check that the spot moves to the left as soon as R212 is turned.

g. ADJUST—R212 so that the spot is just on the center vertical graticule line for both settings of the POLARITY switch.

NOTE

The 176 collector supply pulses will look like slashes on the Type 576 CRT, rather than spots, if the 300 μ s gating pulses are too long or if the delay time between the rise of a gating pulse and the unblanking of the Type 576 CRT is too short. The positions of the coils in the 176 charge lines also affect the shapes of the collector supply pulses.

The width of a gating pulse is determined by R37 in the Type 576 step generator circuit. The unblanking delay time is determined by C50. If the collector supply pulses look like slashes, R37 should be re-

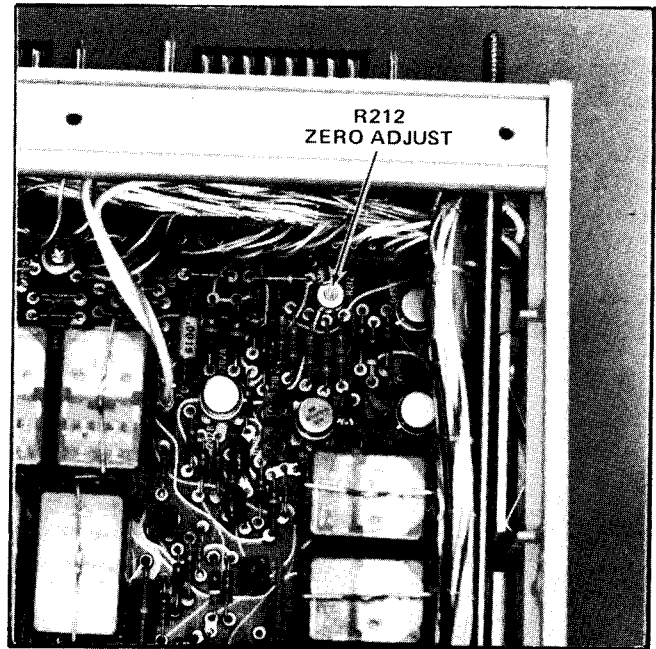

Fig. 5-2. Location of R212 on 176 bottom side.

placed by a 24 k Ω , 1/8 watt, 1% resistor, and C50 should be replaced by an 0.012 μ F, 100 V, 5% capacitor. These component changes will be made in future Type 576's.

The positions of the 176 coils are adjusted in the factory and should normally not require readjustment. The coils may require readjustment, however, if a charge line is repaired or if its capacitance changes due to capacitor aging. Instructions for servicing the charge lines are given in the maintenance section.

REPLACEABLE ELECTRICAL PARTS

PARTS ORDERING INFORMATION

Replacement parts are available from or through your local Tektronix, Inc. Field Office or representative.

Changes to Tektronix instruments are sometimes made to accommodate improved components as they become available, and to give you the benefit of the latest circuit improvements developed in our engineering department. It is therefore important, when ordering parts, to include the following information in your order: Part number, instrument type or number, serial number, and modification number if applicable.

If a part you have ordered has been replaced with a new or improved part, your local Tektronix, Inc. Field Office or representative will contact you concerning any change in part number.

Change information, if any, is located at the rear of this manual.

SPECIAL NOTES AND SYMBOLS

X000 Part first added at this serial number
00X Part removed after this serial number

ITEM NAME

In the Parts List, an Item Name is separated from the description by a colon (:). Because of space limitations, an Item Name may sometimes appear as incomplete. For further Item Name identification, the U.S. Federal Cataloging Handbook H6-1 can be utilized where possible.

ABBREVIATIONS

ACTR	ACTUATOR	PLSTC	PLASTIC
ASSY	ASSEMBLY	QTZ	QUARTZ
CAP	CAPACITOR	RECP	RECEPTACLE
CER	CERAMIC	RES	RESISTOR
CKT	CIRCUIT	RF	RADIO FREQUENCY
COMP	COMPOSITION	SEL	SELECTED
CONN	CONNECTOR	SEMICOND	SEMICONDUCTOR
ELCTLT	ELECTROLYTIC	SENS	SENSITIVE
ELEC	ELECTRICAL	VAR	VARIABLE
INCAND	INCANDESCENT	WW	WIREWOUND
LED	LIGHT EMITTING DIODE	XFMR	TRANSFORMER
NONWIR	NON WIREWOUND	XTAL	CRYSTAL

CROSS INDEX—MFR. CODE NUMBER TO MANUFACTURER

Mfr. Code	Manufacturer	Address	City, State, Zip
S0545	NIPPON ELECTRIC CO., LTD		TOKYO, JAPAN
00853	SANGAMO ELECTRIC CO., S. CAROLINA DIV.	P O BOX 128	PICKENS, SC 29671
01121	ALLEN-BRADLEY COMPANY	1201 2ND STREET SOUTH	MILWAUKEE, WI 53204
01295	TEXAS INSTRUMENTS, INC., SEMICONDUCTOR GROUP	P O BOX 5012, 13500 N CENTRAL EXPRESSWAY	DALLAS, TX 75222
02660	BUNKER RAMO CORP., CONNECTOR DIVISION	2801 S 25TH AVENUE	BROADVIEW, IL 60153
02735	RCA CORPORATION, SOLID STATE DIVISION	ROUTE 202	SOMERVILLE, NY 08876
03508	GENERAL ELECTRIC COMPANY, SEMI-CONDUCTOR PRODUCTS DEPARTMENT	ELECTRONICS PARK	SYRACUSE, NY 13201
03797	GENISCO TECHNOLOGY CORP, ELDEMA DIV.	18435 SUSANA ROAD	COMPTON, CA 90221
04713	MOTOROLA, INC., SEMICONDUCTOR PROD. DIV.	5005 E MCDOWELL RD, PO BOX 20923	PHOENIX, AZ 85036
07263	FAIRCHILD SEMICONDUCTOR, A DIV. OF FAIRCHILD CAMERA AND INSTRUMENT CORP.	464 ELLIS STREET	MOUNTAIN VIEW, CA 94042
12954	SIEMENS CORPORATION, COMPONENTS GROUP	8700 E THOMAS RD, P O BOX 1390	SCOTTSDALE, AZ 85252
15238	ITT SEMICONDUCTORS, A DIVISION OF INTER NATIONAL TELEPHONE AND TELEGRAPH CORP.	P.O. BOX 168, 500 BROADWAY	LAWRENCE, MA 01841
23936	PAMOTOR DIV., WILLIAM J PURDY COMPANY	770 AIRPORT BLVD.	BURLINGAME, CA 94010
56289	SPRAGUE ELECTRIC CO.	87 MARSHALL ST.	NORTH ADAMS, MA 01247
71400	BUSSMAN MFG., DIVISION OF MCGRAW-EDISON CO.	2536 W. UNIVERSITY ST.	ST. LOUIS, MO 63107
71744	CHICAGO MINIATURE LAMP WORKS	4433 RAVENSWOOD AVE.	CHICAGO, IL 60640
72982	ERIE TECHNOLOGICAL PRODUCTS, INC.	644 W. 12TH ST.	ERIE, PA 16512
73138	BECKMAN INSTRUMENTS, INC., HELIPOT DIV.	2500 HARBOR BLVD.	FULLERTON, CA 92634
77342	AMF INC., POTTER AND BRUMFIELD DIV.	200 RICHLAND CREEK DRIVE	PRINCETON, IN 47670
80009	TEKTRONIX, INC.	P O BOX 500	BEAVERTON, OR 97077
81483	INTERNATIONAL RECTIFIER CORP.	9220 SUNSET BLVD.	LOS ANGELES, CA 90069
84411	TRW ELECTRONIC COMPONENTS, TRW CAPACITORS	112 W. FIRST ST.	OGALLALA, NE 69153
87034	ILLUMINATED PRODUCTS INC., A SUB OF OAK INDUSTRIES, INC.	2620 SUSAN ST, PO BOX 11930	SANTA ANA, CA 92711
90201	MALLORY CAPACITOR CO., DIV. OF P. R. MALLORY AND CO., INC.	3029 E. WASHINGTON STREET P. O. BOX 372	INDIANAPOLIS, IN 46206
91637	DALE ELECTRONICS, INC.	P. O. BOX 609	COLUMBUS, NE 68601

Ckt No.	Tektronix Part No.	Serial/Model No. Eff	Dscont	Name & Description	Mfr Code	Mfr Part Number
A1	670-0337-00	B010100	B049999	CKT BOARD ASSY:MAIN	80009	670-0337-00
A1	670-0337-01	B050000		CKT BOARD ASSY:MAIN	80009	670-0337-01
A2	670-0359-00			CKT BOARD ASSY:350 VOLT LINE	80009	670-0359-00
A3	670-0338-00			CKT BOARD ASSY:15 VOLT LINE	80009	670-0338-00
A4	670-0339-00			CKT BOARD ASSY:75 VOLT LINE	80009	670-0339-00
A5	670-0366-00			CKT BOARD ASSY:CAP & RECT BRIDGE	80009	670-0366-00
A6	670-1256-00			CKT BOARD ASSY:PUSH SWITCH	80009	670-1256-00
B275	119-0215-00			FAN,AXIAL:115V,50-60 HZ,18W	23936	8500D
C209	283-0154-00	XB010124		CAP.,FXD,CER DI:22PF,5%,50V	72982	8111B061C0G220J
C218	283-0599-00			CAP.,FXD,MICA D:98PF,5%,500V	00853	D105E980J0
C219	285-0626-00			CAP.,FXD,PLSTC:0.0015UF,10%,100V	56289	410P102
C238	283-0176-00			CAP.,FXD,CER DI:0.0022UF,20%,50V	72982	8121B058X7R0222M
C260	283-0197-00			CAP.,FXD,CER DI:470PF,5%,100V	72982	8121N075C0G0471J
C265	283-0599-00			CAP.,FXD,MICA D:98PF,5%,500V	00853	D105E980J0
C275A-H	290-0487-00			CAP.,FXD,ELCTLT:420UF,+75-10%,30V	56289	112D157
C301	283-0177-00			CAP.,FXD,CER DI:1UF,+80-20%,25V	56289	273C5
C305	283-0187-00			CAP.,FXD,CER DI:0.047UF,10%,400V	72982	8131N401X5R0473K
C310	283-0187-00			CAP.,FXD,CER DI:0.047UF,10%,400V	72982	8131N401X5R0473K
C315	283-0239-00			CAP.,FXD,CER DI:0.022UF,10%,50V	72982	8121N083X7R0223K
C319	283-0239-00			CAP.,FXD,CER DI:0.022UF,10%,50V	72982	8121N083X7R0223K
C323	283-0177-00			CAP.,FXD,CER DI:1UF,+80-20%,25V	56289	273C5
C325	290-0162-00			CAP.,FXD,ELCTLT:22UF,20%,35V	12954	D22C35M1
C329	283-0177-00			CAP.,FXD,CER DI:1UF,+80-20%,25V	56289	273C5
C335	283-0187-00			CAP.,FXD,CER DI:0.047UF,10%,400V	72982	8131N401X5R0473K
C340	283-0187-00			CAP.,FXD,CER DI:0.047UF,10%,400V	72982	8131N401X5R0473K
C345	283-0239-00			CAP.,FXD,CER DI:0.022UF,10%,50V	72982	8121N083X7R0223K
C349	283-0239-00			CAP.,FXD,CER DI:0.022UF,10%,50V	72982	8121N083X7R0223K
C353	283-0177-00			CAP.,FXD,CER DI:1UF,+80-20%,25V	56289	273C5
C354	290-0162-00			CAP.,FXD,ELCTLT:22UF,20%,35V	12954	D22C35M1
C355A	285-0900-00			CAP.,FXD,PLSTC:0.5UF,5%,450V	84411	TEK64-50454RS
C355B	285-0900-00			CAP.,FXD,PLSTC:0.5UF,5%,450V	84411	TEK64-50454RS
C356A	285-0900-00			CAP.,FXD,PLSTC:0.5UF,5%,450V	84411	TEK64-50454RS
C356B	285-0900-00			CAP.,FXD,PLSTC:0.5UF,5%,450V	84411	TEK64-50454RS
C357A	285-0900-00			CAP.,FXD,PLSTC:0.5UF,5%,450V	84411	TEK64-50454RS
C357B	285-0900-00			CAP.,FXD,PLSTC:0.5UF,5%,450V	84411	TEK64-50454RS
C358A	285-0900-00			CAP.,FXD,PLSTC:0.5UF,5%,450V	84411	TEK64-50454RS
C358B	285-0900-00			CAP.,FXD,PLSTC:0.5UF,5%,450V	84411	TEK64-50454RS
C359A	285-0900-00			CAP.,FXD,PLSTC:0.5UF,5%,450V	84411	TEK64-50454RS
C359B	285-0900-00			CAP.,FXD,PLSTC:0.5UF,5%,450V	84411	TEK64-50454RS
C361	283-0177-00			CAP.,FXD,CER DI:1UF,+80-20%,25V	56289	273C5
C364	285-0900-00			CAP.,FXD,PLSTC:0.5UF,5%,450V	84411	TEK64-50454RS
C365A-D	290-0486-00			CAP.,FXD,ELCTLT:6.8UF,+20-10%,100V	56289	150D797
C366A-D	290-0486-00			CAP.,FXD,ELCTLT:6.8UF,+20-10%,100V	56289	150D797
C367A-D	290-0486-00			CAP.,FXD,ELCTLT:6.8UF,+20-10%,100V	56289	150D797
C368A-D	290-0486-00			CAP.,FXD,ELCTLT:6.8UF,+20-10%,100V	56289	150D797
C369A-D	290-0486-00			CAP.,FXD,ELCTLT:6.8UF,+20-10%,100V	56289	150D797
C369E	290-0486-00			CAP.,FXD,ELCTLT:6.8UF,+20-10%,100V	56289	150D797
C375A-J	290-0425-00			CAP.,FXD,ELCTLT:100UF,20%,20V	90201	THF107M020P1G
C375K	290-0425-00	XB040000		CAP.,FXD,ELCTLT:100UF,20%,20V (NOMINAL VALUE,SELECTED)	90201	THF107M020P1G
C375L	290-0425-00	XB040000		CAP.,FXD,ELCTLT:100UF,20%,20V (NOMINAL VALUE,SELECTED)	90201	THF107M020P1G
C376A-J	290-0425-00	B010100	B039999	CAP.,FXD,ELCTLT:100UF,20%,20V	90201	THF107M020P1G
C376A-I	290-0425-00	B040000		CAP.,FXD,ELCTLT:100UF,20%,20V	90201	THF107M020P1G
C376J	290-0539-00	B040000		CAP.,FXD,ELCTLT:47UF,20%,20V (NOMINAL VALUE,SELECTED)	90201	THF476M020P1F

Replaceable Electrical Parts—176

Ckt No.	Tektronix Part No.	Serial/Model No. Eff	Discont	Name & Description	Mfr Code	Mfr Part Number
C377A-K	290-0425-00	B010100	B039999	CAP., FXD, ELCTLT: 100UF, 20%, 20V	90201	THF107M020P1G
C377A-J	290-0425-00	B040000		CAP., FXD, ELCTLT: 100UF, 20%, 20V	90201	THF107M020P1G
C377K	290-0425-00	B040000		CAP., FXD, ELCTLT: 100UF, 20%, 20V (NOMINAL VALUE, SELECTED)	90201	THF107M020P1G
C378A-J	290-0425-00	B010100	B039999	CAP., FXD, ELCTLT: 100UF, 20%, 20V	90201	THF107M020P1G
C378A-L	290-0425-00	B040000		CAP., FXD, ELCTLT: 100UF, 20%, 20V	90201	THF107M020P1G
C378J	SELECTED	B040000				
C379A-J	290-0425-00			CAP., FXD, ELCTLT: 100UF, 20%, 20V	90201	THF107M020P1G
CR110	152-0141-02			SEMICONV DEVICE: SILICON, 30V, 150MA	01295	1N4152R
CR113	152-0141-02			SEMICONV DEVICE: SILICON, 30V, 150MA	01295	1N4152R
CR115	152-0141-02			SEMICONV DEVICE: SILICON, 30V, 150MA	01295	1N4152R
CR117	152-0141-02			SEMICONV DEVICE: SILICON, 30V, 150MA	01295	1N4152R
CR119	152-0141-02			SEMICONV DEVICE: SILICON, 30V, 150MA	01295	1N4152R
CR120	152-0141-02			SEMICONV DEVICE: SILICON, 30V, 150MA	01295	1N4152R
CR123	152-0141-02			SEMICONV DEVICE: SILICON, 30V, 150MA	01295	1N4152R
CR125	152-0141-02			SEMICONV DEVICE: SILICON, 30V, 150MA	01295	1N4152R
CR127	152-0141-02			SEMICONV DEVICE: SILICON, 30V, 150MA	01295	1N4152R
CR129	152-0141-02			SEMICONV DEVICE: SILICON, 30V, 150MA	01295	1N4152R
CR130	152-0141-02			SEMICONV DEVICE: SILICON, 30V, 150MA	01295	1N4152R
CR131	152-0141-02			SEMICONV DEVICE: SILICON, 30V, 150MA	01295	1N4152R
CR134	152-0141-02			SEMICONV DEVICE: SILICON, 30V, 150MA	01295	1N4152R
CR135	152-0141-02			SEMICONV DEVICE: SILICON, 30V, 150MA	01295	1N4152R
CR150	152-0141-02			SEMICONV DEVICE: SILICON, 30V, 150MA	01295	1N4152R
CR151	152-0141-02			SEMICONV DEVICE: SILICON, 30V, 150MA	01295	1N4152R
CR152	152-0141-02			SEMICONV DEVICE: SILICON, 30V, 150MA	01295	1N4152R
CR153	152-0141-02			SEMICONV DEVICE: SILICON, 30V, 150MA	01295	1N4152R
CR154	152-0141-02			SEMICONV DEVICE: SILICON, 30V, 150MA	01295	1N4152R
CR155	152-0141-02			SEMICONV DEVICE: SILICON, 30V, 150MA	01295	1N4152R
CR156	152-0141-02			SEMICONV DEVICE: SILICON, 30V, 150MA	01295	1N4152R
CR236	152-0141-02			SEMICONV DEVICE: SILICON, 30V, 150MA	01295	1N4152R
CR240	152-0141-02			SEMICONV DEVICE: SILICON, 30V, 150MA	01295	1N4152R
CR241	152-0141-02			SEMICONV DEVICE: SILICON, 30V, 150MA	01295	1N4152R
CR250	152-0141-02			SEMICONV DEVICE: SILICON, 30V, 150MA	01295	1N4152R
CR251	152-0141-02			SEMICONV DEVICE: SILICON, 30V, 150MA	01295	1N4152R
CR258	152-0198-00			SEMICONV DEVICE: SILICON, 200V, 3A	03508	1N5624
CR260	152-0141-02			SEMICONV DEVICE: SILICON, 30V, 150MA	01295	1N4152R
CR261	152-0141-02			SEMICONV DEVICE: SILICON, 30V, 150MA	01295	1N4152R
CR268	152-0198-00			SEMICONV DEVICE: SILICON, 200V, 3A	03508	1N5624
CR270	152-0141-02			SEMICONV DEVICE: SILICON, 30V, 150MA	01295	1N4152R
CR275	152-0497-00			SEMICONV DEVICE: SILICON, 600V, 1.5A	80009	152-0497-00
CR310	152-0141-02			SEMICONV DEVICE: SILICON, 30V, 150MA	01295	1N4152R
CR311	152-0141-02			SEMICONV DEVICE: SILICON, 30V, 150MA	01295	1N4152R
CR314	152-0141-02			SEMICONV DEVICE: SILICON, 30V, 150MA	01295	1N4152R
CR320	152-0141-02			SEMICONV DEVICE: SILICON, 30V, 150MA	01295	1N4152R
CR321	152-0333-00			SEMICONV DEVICE: SILICON, 55V, 200MA	07263	FDH-6012
CR322	152-0040-00			SEMICONV DEVICE: SILICON, 600V, 1A	15238	LG109
CR323	152-0040-00			SEMICONV DEVICE: SILICON, 600V, 1A	15238	LG109
CR325	152-0479-00			SEMICONV DEVICE: SILICON, 300V, 12A	81483	80-0182
CR328	152-0040-00			SEMICONV DEVICE: SILICON, 600V, 1A	15238	LG109
CR330	152-0141-02			SEMICONV DEVICE: SILICON, 30V, 150MA	01295	1N4152R
CR331	152-0040-00			SEMICONV DEVICE: SILICON, 600V, 1A	15238	LG109
CR340	152-0141-02			SEMICONV DEVICE: SILICON, 30V, 150MA	01295	1N4152R
CR341	152-0141-02			SEMICONV DEVICE: SILICON, 30V, 150MA	01295	1N4152R
CR346	152-0141-02			SEMICONV DEVICE: SILICON, 30V, 150MA	01295	1N4152R
CR350	152-0141-02			SEMICONV DEVICE: SILICON, 30V, 150MA	01295	1N4152R
CR351	152-0333-00			SEMICONV DEVICE: SILICON, 55V, 200MA	07263	FDH-6012
CR352	152-0141-02			SEMICONV DEVICE: SILICON, 30V, 150MA	01295	1N4152R
CR353	152-0333-00			SEMICONV DEVICE: SILICON, 55V, 200MA	07263	FDH-6012
CR355	152-0040-00			SEMICONV DEVICE: SILICON, 600V, 1A	15238	LG109

Ckt No.	Tektronix Part No.	Serial/Model No. Eff	Dscont	Name & Description	Mfr Code	Mfr Part Number
CR356	152-0040-00			SEMICON D DEVICE: SILICON, 600V, 1A	15238	LG109
CR358	152-0141-02	XB040000		SEMICON D DEVICE: SILICON, 30V, 150MA	01295	1N4152R
CR359	152-0040-00			SEMICON D DEVICE: SILICON, 600V, 1A	15238	LG109
CR360	152-0141-02	XB040000		SEMICON D DEVICE: SILICON, 30V, 150MA	01295	1N4152R
CR365	152-0418-00			SEMICON D DEVICE: RECT, SI, 300V, 3MA	80009	152-0418-00
CR366	152-0418-00			SEMICON D DEVICE: RECT, SI, 300V, 3MA	80009	152-0418-00
CR367	152-0418-00			SEMICON D DEVICE: RECT, SI, 300V, 3MA	80009	152-0418-00
CR368	152-0418-00			SEMICON D DEVICE: RECT, SI, 300V, 3MA	80009	152-0418-00
CR369	152-0418-00			SEMICON D DEVICE: RECT, SI, 300V, 3MA	80009	152-0418-00
CR375	152-0198-00			SEMICON D DEVICE: SILICON, 200V, 3A	03508	1N5624
CR376	152-0198-00			SEMICON D DEVICE: SILICON, 200V, 3A	03508	1N5624
CR377	152-0198-00			SEMICON D DEVICE: SILICON, 200V, 3A	03508	1N5624
CR378	152-0198-00			SEMICON D DEVICE: SILICON, 200V, 3A	03508	1N5624
CR379	152-0198-00			SEMICON D DEVICE: SILICON, 200V, 3A	03508	1N5624
CR380	152-0141-02			SEMICON D DEVICE: SILICON, 30V, 150MA	01295	1N4152R
CR381	152-0141-02			SEMICON D DEVICE: SILICON, 30V, 150MA	01295	1N4152R
CR390	152-0141-02			SEMICON D DEVICE: SILICON, 30V, 150MA	01295	1N4152R
CR391	152-0141-02			SEMICON D DEVICE: SILICON, 30V, 150MA	01295	1N4152R
DS106	150-0107-00	B010100	B070909	LAMP, INCAND: 12V, 0.04A, T-1	87034	227AS25
DS106	150-0180-00	B070910		LAMP, INCAND: 12V, 0.06A	71744	CM7219
DS110	150-0107-00	B010100	B070909	LAMP, INCAND: 12V, 0.04A, T-1	87034	227AS25
DS110	150-0180-00	B070910		LAMP, INCAND: 12V, 0.06A	71744	CM7219
DS120	150-0107-00	B010100	B070909	LAMP, INCAND: 12V, 0.04A, T-1	87034	227AS25
DS120	150-0180-00	B070910		LAMP, INCAND: 12V, 0.06A	71744	CM7219
DS130	150-0107-00	B010100	B070909	LAMP, INCAND: 12V, 0.04A, T-1	87034	227AS25
DS130	150-0180-00	B070910		LAMP, INCAND: 12V, 0.06A	71744	CM7219
DS150	150-0107-00	B010100	B070909	LAMP, INCAND: 12V, 0.04A, T-1	87034	227AS25
DS150	150-0180-00	B070910		LAMP, INCAND: 12V, 0.06A	71744	CM7219
DS160	150-0090-00			LAMP, CARTRIDGE: 14V, 0.08A, RED LENS	03797	CS03-RTS-2182
F275	159-0090-00			FUSE, CARTRIDGE: 0.25A, 125V, FAST-BLOW	71400	GAF 1/4
J300	136-0140-00			JACK, TIP: BANANA STYLE, CHARCOAL GRAY CA	80009	136-0140-00
J310	136-0140-00			JACK, TIP: BANANA STYLE, CHARCOAL GRAY CA	80009	136-0140-00
K110	148-0065-00			RELAY, ARMATURE: 4 FORM C, 12VDC	77342	R10-E1256-1
K120	148-0065-00			RELAY, ARMATURE: 4 FORM C, 12VDC	77342	R10-E1256-1
K130	148-0065-00			RELAY, ARMATURE: 4 FORM C, 12VDC	77342	R10-E1256-1
K150	148-0067-00			RELAY, ARMATURE: 4 FORM C, 12VDC	77342	R10-E1397-1
K240	148-0068-00			RELAY, ARMATURE: 2 FORM C, 12VDC	77342	R10-E1254-1
K250	148-0068-00			RELAY, ARMATURE: 2 FORM C, 12VDC	77342	R10-E1254-1
K260	148-0068-00			RELAY, ARMATURE: 2 FORM C, 12VDC	77342	R10-E1254-1
K270	148-0068-00			RELAY, ARMATURE: 2 FORM C, 12VDC	77342	R10-E1254-1
K310	148-0065-00			RELAY, ARMATURE: 4 FORM C, 12VDC	77342	R10-E1256-1
K320	148-0065-00			RELAY, ARMATURE: 4 FORM C, 12VDC	77342	R10-E1256-1
K330	148-0065-00			RELAY, ARMATURE: 4 FORM C, 12VDC	77342	R10-E1256-1
K340	148-0066-00			RELAY, ARMATURE: 4 FORM C, 12VDC	77342	R10-E1255-1
K350	148-0069-00			RELAY, ARMATURE: 1 FORM X, 12VDC, 50A	77342	MB-1347
K355	148-0069-00			RELAY, ARMATURE: 1 FORM X, 12VDC, 50A	77342	MB-1347
K380	148-0069-00			RELAY, ARMATURE: 1 FORM X, 12VDC, 50A	77342	MB-1347
K390	148-0069-00			RELAY, ARMATURE: 1 FORM X, 12VDC, 50A	77342	MB-1347
L355	108-0636-00			COIL, RF: FIXED, 1.9MH	80009	108-0636-00
L356	108-0634-00			COIL, RF: FIXED, 940UH	80009	108-0634-00
L357	108-0634-00			COIL, RF: FIXED, 940UH	80009	108-0634-00
L358	108-0634-00			COIL, RF: FIXED, 940UH	80009	108-0634-00
L359	108-0635-00			COIL, RF: FIXED, 1.14MH	80009	108-0635-00
L365	108-0633-00			COIL, RF: FIXED, 68UH	80009	108-0633-00
L366	108-0631-00			COIL, RF: FIXED, 39UH	80009	108-0631-00
L367	108-0631-00			COIL, RF: FIXED, 39UH	80009	108-0631-00
L368	108-0631-00			COIL, RF: FIXED, 39UH	80009	108-0631-00

Replaceable Electrical Parts—176

Ckt No.	Tektronix Part No.	Serial/Model No. Eff	Dscont	Name & Description	Mfr Code	Mfr Part Number
L369	108-0632-00			COIL, RF: FIXED, 4.3UH	80009	108-0632-00
L375A-E	108-0637-00			COIL, RF: FIXED, 7.8UH	80009	108-0637-00
P360	131-0096-00			CONN, RCPT, ELEC: 32 CONTACT, MALE	02660	26-159-32
P361	131-0017-00			CONNECTOR, RCPT, :16 CONTACT, MALE	02660	26-159-16
P362	131-0017-00			CONNECTOR, RCPT, :16 CONTACT, MALE	02660	26-159-16
P363	131-0149-00			CONNECTOR, RCPT, :24 CONTACT, MALE	02660	26-159-24
Q104	151-0164-00			TRANSISTOR: SILICON, PNP	01295	SKB3334
Q106	151-0164-00			TRANSISTOR: SILICON, PNP	01295	SKB3334
Q110	151-0207-00			TRANSISTOR: SILICON, NPN	03508	X32D6191
Q120	151-0207-00			TRANSISTOR: SILICON, NPN	03508	X32D6191
Q130	151-0207-00	B010100	B069999	TRANSISTOR: SILICON, NPN	03508	X32D6191
Q130	151-0281-00	B070000		TRANSISTOR: SILICON, NPN	03508	X16P4039
Q132	151-0207-00			TRANSISTOR: SILICON, NPN	03508	X32D6191
Q134	151-0207-00			TRANSISTOR: SILICON, NPN	03508	X32D6191
Q136	151-0207-00			TRANSISTOR: SILICON, NPN	03508	X32D6191
Q150	151-0207-00	B010100	B069999	TRANSISTOR: SILICON, NPN	03508	X32D6191
Q150	151-0281-00	B070000		TRANSISTOR: SILICON, NPN	03508	X16P4039
Q152	151-0207-00			TRANSISTOR: SILICON, NPN	03508	X32D6191
Q202A, B	151-0232-00			TRANSISTOR: SILICON, NPN, DUAL	80009	151-0232-00
Q208A, B	151-0232-00			TRANSISTOR: SILICON, NPN, DUAL	80009	151-0232-00
Q210	151-0188-00			TRANSISTOR: SILICON, PNP	04713	SPS6868K
Q218	151-0188-00			TRANSISTOR: SILICON, PNP	04713	SPS6868K
Q230	151-0190-00			TRANSISTOR: SILICON, NPN	07263	S032677
Q236	151-0190-00			TRANSISTOR: SILICON, NPN	07263	S032677
Q250	151-0192-00			TRANSISTOR: SILICON, NPN, SEL FROM MPS6521	04713	SPS8801
Q254	151-0290-00			TRANSISTOR: SILICON, NPN	80009	151-0290-00
Q258	151-0319-00			TRANSISTOR: SILICON, NPN	80009	151-0319-00
Q260	151-0276-00			TRANSISTOR: SILICON, PNP	80009	151-0276-00
Q264	151-0290-00			TRANSISTOR: SILICON, NPN	80009	151-0290-00
Q268	151-0319-00			TRANSISTOR: SILICON, NPN	80009	151-0319-00
Q270	151-0207-00			TRANSISTOR: SILICON, NPN	03508	X32D6191
Q302	151-0190-00			TRANSISTOR: SILICON, NPN	07263	S032677
Q306	151-0190-00			TRANSISTOR: SILICON, NPN	07263	S032677
Q312	151-0207-00			TRANSISTOR: SILICON, NPN	03508	X32D6191
Q316	151-0207-00			TRANSISTOR: SILICON, NPN	03508	X32D6191
Q322	151-0260-00			TRANSISTOR: SILICON, NPN	80009	151-0260-00
Q324	151-0511-00			SCR: SILICON	02735	2N4103
Q326	151-0260-00			TRANSISTOR: SILICON, NPN	80009	151-0260-00
Q328	151-0511-00			SCR: SILICON	02735	2N4103
Q330	151-0511-00			SCR: SILICON	02735	2N4103
Q336	151-0190-00			TRANSISTOR: SILICON, NPN	07263	S032677
Q342	151-0207-00			TRANSISTOR: SILICON, NPN	03508	X32D6191
Q346	151-0207-00			TRANSISTOR: SILICON, NPN	03508	X32D6191
Q350	151-0260-00			TRANSISTOR: SILICON, NPN	80009	151-0260-00
Q352	151-0206-00			TRANSISTOR: SILICON, NPN	S0545	2SC288A
Q354	151-0512-00			SCR: SILICON	81483	68-5343
Q356	151-0260-00			TRANSISTOR: SILICON, NPN	80009	151-0260-00
Q358	151-0512-00			SCR: SILICON	81483	68-5343
Q360	151-0512-00			SCR: SILICON	81483	68-5343
Q380	151-0207-00			TRANSISTOR: SILICON, NPN	03508	X32D6191
Q390	151-0207-00			TRANSISTOR: SILICON, NPN	03508	X32D6191
R102	315-0473-00			RES., FXD, CMPSN: 47K OHM, 5%, 0.25W	01121	CB4735
R103	315-0473-00			RES., FXD, CMPSN: 47K OHM, 5%, 0.25W	01121	CB4735
R104	315-0103-00			RES., FXD, CMPSN: 10K OHM, 5%, 0.25W	01121	CB1035
R110	315-0102-00			RES., FXD, CMPSN: 1K OHM, 5%, 0.25W	01121	CB1025
R113	315-0433-00			RES., FXD, CMPSN: 43K OHM, 5%, 0.25W	01121	CB4335

Ckt No.	Tektronix Part No.	Serial/Model No. Eff	Dscont	Name & Description	Mfr Code	Mfr Part Number
R115	315-0182-00			RES., FXD, CMPSN: 1.8K OHM, 5%, 0.25W	01121	CB1825
R120	315-0102-00			RES., FXD, CMPSN: 1K OHM, 5%, 0.25W	01121	CB1025
R123	315-0433-00			RES., FXD, CMPSN: 43K OHM, 5%, 0.25W	01121	CB4335
R125	315-0182-00			RES., FXD, CMPSN: 1.8K OHM, 5%, 0.25W	01121	CB1825
R130	301-0433-00			RES., FXD, CMPSN: 43K OHM, 5%, 0.50W	01121	EB4335
R132	315-0102-00			RES., FXD, CMPSN: 1K OHM, 5%, 0.25W	01121	CB1025
R135	315-0105-00			RES., FXD, CMPSN: 1M OHM, 5%, 0.25W	01121	CB1055
R136	315-0124-00			RES., FXD, CMPSN: 120K OHM, 5%, 0.25W	01121	CB1245
R137	315-0474-00			RES., FXD, CMPSN: 470K OHM, 5%, 0.25W	01121	CB4745
R138	315-0473-00			RES., FXD, CMPSN: 47K OHM, 5%, 0.25W	01121	CB4735
R139	315-0474-00			RES., FXD, CMPSN: 470K OHM, 5%, 0.25W	01121	CB4745
R140	315-0473-00			RES., FXD, CMPSN: 47K OHM, 5%, 0.25W	01121	CB4735
R150	301-0433-00			RES., FXD, CMPSN: 43K OHM, 5%, 0.50W	01121	EB4335
R152	315-0102-00			RES., FXD, CMPSN: 1K OHM, 5%, 0.25W	01121	CB1025
R153	315-0333-00			RES., FXD, CMPSN: 33K OHM, 5%, 0.25W	01121	CB3335
R155	315-0391-00			RES., FXD, CMPSN: 390 OHM, 5%, 0.25W	01121	CB3915
R201	315-0221-00			RES., FXD, CMPSN: 220 OHM, 5%, 0.25W	01121	CB2215
R202	301-0153-00			RES., FXD, CMPSN: 15K OHM, 5%, 0.50W	01121	EB1535
R203	301-0153-00			RES., FXD, CMPSN: 15K OHM, 5%, 0.50W	01121	EB1535
R204	321-0239-07			RES., FXD, FILM: 3.01K OHM, 0.1%, 0.125W	91637	MFF1816C30100B
R205	315-0221-00			RES., FXD, CMPSN: 220 OHM, 5%, 0.25W	01121	CB2215
R206	321-0666-07	B010100	B069999	RES., FXD, FILM: 3.04K OHM, 0.1%, 0.125W	91637	MFF1816C30400B
R206	321-0239-07	B070000		RES., FXD, FILM: 3.01K OHM, 0.1%, 0.125W	91637	MFF1816C30100B
R207	321-0239-07			RES., FXD, FILM: 3.01K OHM, 0.1%, 0.125W	91637	MFF1816C30100B
R208	315-0105-00			RES., FXD, CMPSN: 1M OHM, 5%, 0.25W	01121	CB1055
R209	315-0105-00			RES., FXD, CMPSN: 1M OHM, 5%, 0.25W	01121	CB1055
R210	321-0431-00			RES., FXD, FILM: 301K OHM, 1%, 0.125W	91637	MFF1816G30102F
R212	311-0644-00			RES., VAR, NONWIR: 20K OHM, 10%, 0.50W	73138	82-34-1
R216	315-0124-00			RES., FXD, CMPSN: 120K OHM, 5%, 0.25W	01121	CB1245
R218	315-0164-00			RES., FXD, CMPSN: 160K OHM, 5%, 0.25W	01121	CB1645
R219	321-0239-07	B010100	B069999	RES., FXD, FILM: 3.01K OHM, 0.1%, 0.125W	91637	MFF1816C30100B
R219	321-0666-07	B070000		RES., FXD, FILM: 3.04K OHM, 0.1%, 0.125W	91637	MFF1816C30400B
R220	315-0203-00			RES., FXD, CMPSN: 20K OHM, 5%, 0.25W	01121	CB2035
R230	315-0472-00			RES., FXD, CMPSN: 4.7K OHM, 5%, 0.25W	01121	CB4725
R231	315-0563-00			RES., FXD, CMPSN: 56K OHM, 5%, 0.25W	01121	CB5635
R232	315-0102-00			RES., FXD, CMPSN: 1K OHM, 5%, 0.25W	01121	CB1025
R234	315-0123-00			RES., FXD, CMPSN: 12K OHM, 5%, 0.25W	01121	CB1235
R236	315-0103-00			RES., FXD, CMPSN: 10K OHM, 5%, 0.25W	01121	CB1035
R238	315-0224-00			RES., FXD, CMPSN: 220K OHM, 5%, 0.25W	01121	CB2245
R250	315-0472-00			RES., FXD, CMPSN: 4.7K OHM, 5%, 0.25W	01121	CB4725
R254	315-0471-00			RES., FXD, CMPSN: 470 OHM, 5%, 0.25W	01121	CB4715
R255	315-0120-00	B010100	B071169	RES., FXD, CMPSN: 12 OHM, 5%, 0.25W	01121	CB1205
R255	315-0120-01	B071170		RES., FXD, CMPSN: 12 OHM, 5%, 0.25W	01121	CB1205
R260	315-0472-00			RES., FXD, CMPSN: 4.7K OHM, 5%, 0.25W	01121	CB4725
R264	315-0471-00			RES., FXD, CMPSN: 470 OHM, 5%, 0.25W	01121	CB4715
R265	307-0267-00			RES., FXD, FILM: COMBINATION W/TAP	80009	307-0267-00
R270	315-0123-00			RES., FXD, CMPSN: 12K OHM, 5%, 0.25W	01121	CB1235
R301	315-0223-00			RES., FXD, CMPSN: 22K OHM, 5%, 0.25W	01121	CB2235
R302	315-0103-00			RES., FXD, CMPSN: 10K OHM, 5%, 0.25W	01121	CB1035
R304	315-0562-00			RES., FXD, CMPSN: 5.6K OHM, 5%, 0.25W	01121	CB5625
R305	315-0102-00			RES., FXD, CMPSN: 1K OHM, 5%, 0.25W	01121	CB1025
R306	315-0102-00			RES., FXD, CMPSN: 1K OHM, 5%, 0.25W	01121	CB1025
R308	315-0102-00			RES., FXD, CMPSN: 1K OHM, 5%, 0.25W	01121	CB1025
R310	315-0102-00			RES., FXD, CMPSN: 1K OHM, 5%, 0.25W	01121	CB1025
R311	315-0222-00			RES., FXD, CMPSN: 2.2K OHM, 5%, 0.25W	01121	CB2225
R312	315-0623-00			RES., FXD, CMPSN: 62K OHM, 5%, 0.25W	01121	CB6235
R313	315-0152-00			RES., FXD, CMPSN: 1.5K OHM, 5%, 0.25W	01121	CB1525

Replaceable Electrical Parts—176

Ckt No.	Tektronix Part No.	Serial/Model No. Eff	Dscont	Name & Description	Mfr Code	Mfr Part Number
R314	315-0222-00			RES., FXD, CMPSN: 2.2K OHM, 5%, 0.25W	01121	CB2225
R315	315-0101-00			RES., FXD, CMPSN: 100 OHM, 5%, 0.25W	01121	CB1015
R316	315-0623-00			RES., FXD, CMPSN: 62K OHM, 5%, 0.25W	01121	CB6235
R317	315-0152-00			RES., FXD, CMPSN: 1.5K OHM, 5%, 0.25W	01121	CB1525
R318	301-0471-00	XB060000		RES., FXD, CMPSN: 470 OHM, 5%, 0.50W	01121	EB4715
R319	315-0101-00			RES., FXD, CMPSN: 100 OHM, 5%, 0.25W	01121	CB1015
R320	308-0231-00			RES., FXD, WW: 220 OHM, 5%, 3W	91637	RS2B-B220R0J
R321	310-0691-00			RES., FXD, WW: 148 OHM, 5%, 8W	80009	310-0691-00
R322	315-0202-00			RES., FXD, CMPSN: 2K OHM, 5%, 0.25W	01121	CB2025
R323	315-0200-00			RES., FXD, CMPSN: 20 OHM, 5%, 0.25W	01121	CB2005
R324	315-0101-00			RES., FXD, CMPSN: 100 OHM, 5%, 0.25W	01121	CB1015
R325	315-0100-00			RES., FXD, CMPSN: 10 OHM, 5%, 0.25W	01121	CB1005
R326	315-0202-00			RES., FXD, CMPSN: 2K OHM, 5%, 0.25W	01121	CB2025
R327	310-0692-00			RES., FXD, WW: 3.7K OHM, 5%, 8W	80009	310-0692-00
R328	315-0101-00			RES., FXD, CMPSN: 100 OHM, 5%, 0.25W	01121	CB1015
R329	315-0200-00			RES., FXD, CMPSN: 20 OHM, 5%, 0.25W	01121	CB2005
R330	315-0101-00			RES., FXD, CMPSN: 100 OHM, 5%, 0.25W	01121	CB1015
R331	302-0224-00	XB020000		RES., FXD, CMPSN: 220K OHM, 10%, 0.50W	01121	EB2241
R334	315-0562-00				RES., FXD, CMPSN: 5.6K OHM, 5%, 0.25W	01121
R335	315-0102-00			RES., FXD, CMPSN: 1K OHM, 5%, 0.25W	01121	CB1025
R336	315-0102-00			RES., FXD, CMPSN: 1K OHM, 5%, 0.25W	01121	CB1025
R338	315-0102-00			RES., FXD, CMPSN: 1K OHM, 5%, 0.25W	01121	CB1025
R340	315-0102-00			RES., FXD, CMPSN: 1K OHM, 5%, 0.25W	01121	CB1025
R341	315-0222-00			RES., FXD, CMPSN: 2.2K OHM, 5%, 0.25W	01121	CB2225
R342	315-0623-00			RES., FXD, CMPSN: 62K OHM, 5%, 0.25W	01121	CB6235
R343	315-0152-00			RES., FXD, CMPSN: 1.5K OHM, 5%, 0.25W	01121	CB1525
R344	315-0222-00			RES., FXD, CMPSN: 2.2K OHM, 5%, 0.25W	01121	CB2225
R345	315-0101-00			RES., FXD, CMPSN: 100 OHM, 5%, 0.25W	01121	CB1015
R346	315-0623-00			RES., FXD, CMPSN: 62K OHM, 5%, 0.25W	01121	CB6235
R347	315-0152-00			RES., FXD, CMPSN: 1.5K OHM, 5%, 0.25W	01121	CB1525
R348	310-0690-00			RES., FXD, WW: 5 OHM, 5%, 8W	80009	310-0690-00
R349	315-0101-00			RES., FXD, CMPSN: 100 OHM, 5%, 0.25W	01121	CB1015
R350	315-0272-00			RES., FXD, CMPSN: 2.7K OHM, 5%, 0.25W	01121	CB2725
R351	303-0150-02			RES., FXD, CMPSN: 15 OHM, 5%, 1W	01121	GB1505
R352	315-0202-00			RES., FXD, CMPSN: 2K OHM, 5%, 0.25W	01121	CB2025
R353	315-0200-00			RES., FXD, CMPSN: 20 OHM, 5%, 0.25W	01121	CB2005
R354	315-0101-00			RES., FXD, CMPSN: 100 OHM, 5%, 0.25W	01121	CB1015
R355	315-0100-00			RES., FXD, CMPSN: 10 OHM, 5%, 0.25W	01121	CB1005
R356	315-0202-00			RES., FXD, CMPSN: 2K OHM, 5%, 0.25W	01121	CB2025
R357	308-0271-00			RES., FXD, WW: 667 OHM, 5%, 5W	91637	HL60528-667R0J
R358	315-0101-00			RES., FXD, CMPSN: 100 OHM, 5%, 0.25W	01121	CB1015
R359	301-0150-00			RES., FXD, CMPSN: 15 OHM, 5%, 0.50W	01121	EB1505
R360	315-0101-00			RES., FXD, CMPSN: 100 OHM, 5%, 0.25W	01121	CB1015
R361	315-0200-00			RES., FXD, CMPSN: 20 OHM, 5%, 0.25W	01121	CB2005
R362	308-0446-00	B010100	B070929	RES., FXD, WW: 15 OHM, 5%, 5W (LOCATED ON A2)	91637	RS2A-K15R00J
R362	308-0446-01			B070930		
R362	308-0136-00	XB040000			RES., FXD, WW: 0.05 OHM, 10%, 5W (LOCATED ON CHASSIS)	80009
R363	308-0446-00		B010100	B070929	RES., FXD, WW: 15 OHM, 5%, 5W	
R363	308-0446-01	B070930			RES., FXD WW: 15 OHM, 5%, 5W	91637
R364	315-0100-00				RES., FXD, CMPSN: 10 OHM, 5%, 0.25W (LOCATED ON A1)	01121
R364	308-0236-00			RES., FXD, WW: 85 OHM, 5%, 3W (LOCATED ON CHASSIS)	91637	RS2B-B85R00J
R370	302-0682-00	B010100	B010130	RES., FXD, CMPSN: 6.8 OHM, 10%, 0.50W	01121	EB6821
R370	304-0272-00			B010131	RES., FXD, CMPSN: 2.7 OHM, 10%, 1W	01121
R372	302-0682-00	B010100	B010130	RES., FXD, CMPSN: 6.8 OHM, 10%, 0.50W	01121	EB6821
R372	304-0272-00			B010131	RES., FXD, CMPSN: 2.7 OHM, 10%, 1W	01121

Ckt No.	Tektronix Part No.	Serial/Model No. Eff	Dscont	Name & Description	Mfr Code	Mfr Part Number
R381	315-0183-00			RES., FXD, CMPSN: 18K OHM, 5%, 0.25W	01121	CB1835
R382	315-0182-00			RES., FXD, CMPSN: 1.8K OHM, 5%, 0.25W	01121	CB1825
R385	307-0237-00			RES., FXD, FILM: 0.025 OHM, 10W	80009	307-0237-00
R390	301-0751-00			RES., FXD, CMPSN: 750 OHM, 5%, 0.50W	01121	EB7515
R391	315-0822-00			RES., FXD, CMPSN: 8.2K OHM, 5%, 0.25W	01121	CB8225
R392	301-0751-00			RES., FXD, CMPSN: 750 OHM, 5%, 0.50W	01121	EB7515
S106	} -----			(LOCATED ON CHASSIS. FURNISHED AS A UNIT WITH A6)		
S110						
S120						
S130						
S150						
S162						
T275	120-0693-00			XFMR, PWR, STPDN:	80009	120-0693-00
T324	120-0694-00			XFMR ASSEMBLY: DUAL POT CORE	80009	120-0694-00
	-----			(T324 AND T330 FURNISHED AS A PAIR)		
T328	120-0695-00			TRANSFORMER, CUR: POT CORE	80009	120-0695-00
T330	120-0694-00			XFMR ASSEMBLY: DUAL POT CORE	80009	120-0694-00
	-----			(T330 AND T324 FURNISHED AS A PAIR)		
T354	120-0694-00			XFMR ASSEMBLY: DUAL POT CORE	80009	120-0694-00
	-----			(T354 AND T360 FURNISHED AS A PAIR)		
T358	120-0695-00			TRANSFORMER, CUR: POT CORE	80009	120-0695-00
T360	120-0694-00			XFMR ASSEMBLY: DUAL POT CORE	80009	120-0694-00
	-----			(T360 AND T354 FURNISHED AS A PAIR)		
VR275	152-0480-00			SEMICOND DEVICE: ZENER, 10W, 5V, 5%	04713	1N2989B

SECTION 7 DIAGRAMS

Change information, if any, affecting this section will be found at the rear of the manual.

General

The following section contains a block diagram, circuit diagrams, circuit board pictures, mechanical parts illustrations and a repackaging illustration.

Block Diagram

The foldout block diagram shows the interconnection of the 176 and the Type 576 through P360, P361, P362 and P363 on the 176. A functional block diagram is shown in Fig. 4-1 in section 4.

Circuit Diagrams

The foldout circuit diagrams provide complete schematic diagrams of all the circuitry in the 176, pertinent voltages and waveform pictures, and circuit board pictures. The reference standard for the diagrams is the Graphic Symbol Standard USAS 32.2-1967.

Special Symbols. The following special symbols are used in the diagrams:

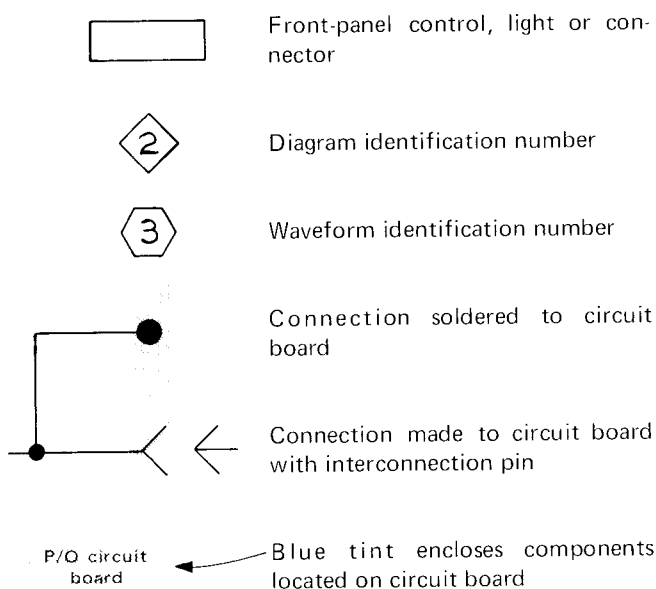

Circuit Number Prefixes. The following abbreviations are used as circuit number prefixes to identify components and assemblies in the diagrams:

A	Assembly, separable or repairable (circuit board, etc.)
B	Motor
C	Capacitor, fixed or variable
CR	Diode, signal or rectifier
DS	Indicating device (lamp)
F	Fuse
K	Relay
L	Inductor, fixed or variable
Q	Transistor or silicon-controlled rectifier
P	Connector, movable portion
R	Resistor, fixed or variable
S	Switch
T	Transformer

Circuit Boards. Circuit board pictures accompany each circuit diagram which illustrates circuit board-mounted components. They are located either on the apron of the diagram or on the back of the preceding diagram. The components are identified on the circuit board pictures by their circuit numbers.

Assembly numbers. Each circuit board in the 176 has been given an assembly number, A1, A2, etc. These numbers are helpful in locating components in the instrument and in the electrical parts list. In the circuit diagrams, the circuit board-mounted components are enclosed by a heavy blue tinted line. The circuit board title and assembly number is indicated within this line. The circuit board pictures accompanying the diagram are also identified by their titles and assembly numbers. In the electrical parts list, there is a list of components for each circuit board (each list identified by an assembly number) and a separate list of chassis mounted components. Table 7-1 lists the circuit board, their assembly numbers and the diagrams they can be found on.

Table 7-1
Locations of Circuit Boards on Circuit Diagrams

Board Title	Assembly No.	Diagram
Main	A1	1, 2, 3
350 Volt Line	A2	4
15 Volt Line	A3	4
75 Volt Line	A4	4
8 Cap. Mtg.	A5	2
Push Switch	A6	1

Diagrams—176

Voltages and Waveforms. Typical voltage measurements and waveform photographs are shown in blue on the diagrams (or diagram aprons). These voltages and waveforms are not absolute and may vary between instruments because of differing component tolerances, internal adjustment or front-panel settings.

Test Oscilloscope, with 10X Probe

Bandwidth	DC to 50 MHz
Probe Input Impedance	10 Megohms, 7 picofarads
Probe Ground	176 Chassis
Triggering	Internal

DC Voltmeter

Type	Digital Volt-Ohmmeter
Reference Voltage	176 Chassis

Control Settings

176

MAX PEAK POWER-WATT	100
X10 VERT	Not illuminated
X10 STEP	Illuminated
INTERLOCK OVERRIDE	Not pressed

Type 576

READOUT ILLUM	Visible Readout
GRATICULE ILLUM	Visible Graticule Line
INTENSITY	Visible Display
FOCUS	Centered
VERTICAL	50 mA
DISPLAY OFFSET	NORM (OFF)
Selector	
CENTERLINE VALUE	0
HORIZONTAL	2 V COLLECTOR
Vertical Position	Centered
Horizontal Position	Centered
DISPLAY INVERT	Released
MAX PEAK VOLTS	15
PEAK POWER WATTS	Has no effect
VARIABLE COLLECTOR	10 V Collector Supply
Output	
POLARITY	+(NPN)
MODE	NORM
LOOPING COMPENSATION	Has no effect
NUMBER OF STEPS	10
CURRENT LIMIT	2 A
AMPLITUDE	10 mA
OFFSET	AID
OFFSET MULT	2.0

STEPS	Released
PULSED STEPS	300 μ S
POLARITY INVERT	Released
STEP MULT .1X	Released

Relays. In many cases, a relay contact is located on a different circuit diagram than its coil. Table 7-2 lists the circuit numbers of the relays used in the instrument, and shows the diagrams on which the coils and the contacts are found. If a contact on a particular relay is not listed, it is not used in the circuit.

Table 7-2

Location of Relay Coils and Contacts
Circuit Diagrams

Relay	Diagrams		
	1	2	3
K110	Coil, S1		S2, S3, S4
K120	Coil, S1		S2, S3, S4
K130	Coil, S1	S2, S3, S4	
K150	Coil, S1		S2, S3
K240		Coil, S1	
K250		Coil, S1	
K260		Coil, S1, S2	
K270		Coil, S1, S2	
K310			Coil, S1, S2, S3, S4
K320			Coil, S1, S2, S3, S4
K330			Coil, S1, S2, S3, S4
K340			Coil, S1, S2, S3, S4
K350			Coil ¹
K355			Coil ¹
K380			Coil ¹
K390			Coil ¹

¹ The contacts on these coils are not labeled. They are located on the same diagrams as their coils.

Mechanical Parts Illustrations

Mechanical parts illustrations, including a repackaging illustration are given on the back of the foldout circuits diagrams. The mechanical parts list following these diagrams provide a list of mechanical parts for each diagram. See the beginning of the Mechanical Parts List section for parts ordering information.



PUSH SWITCH Circuit Board A6

MODE SWITCHING



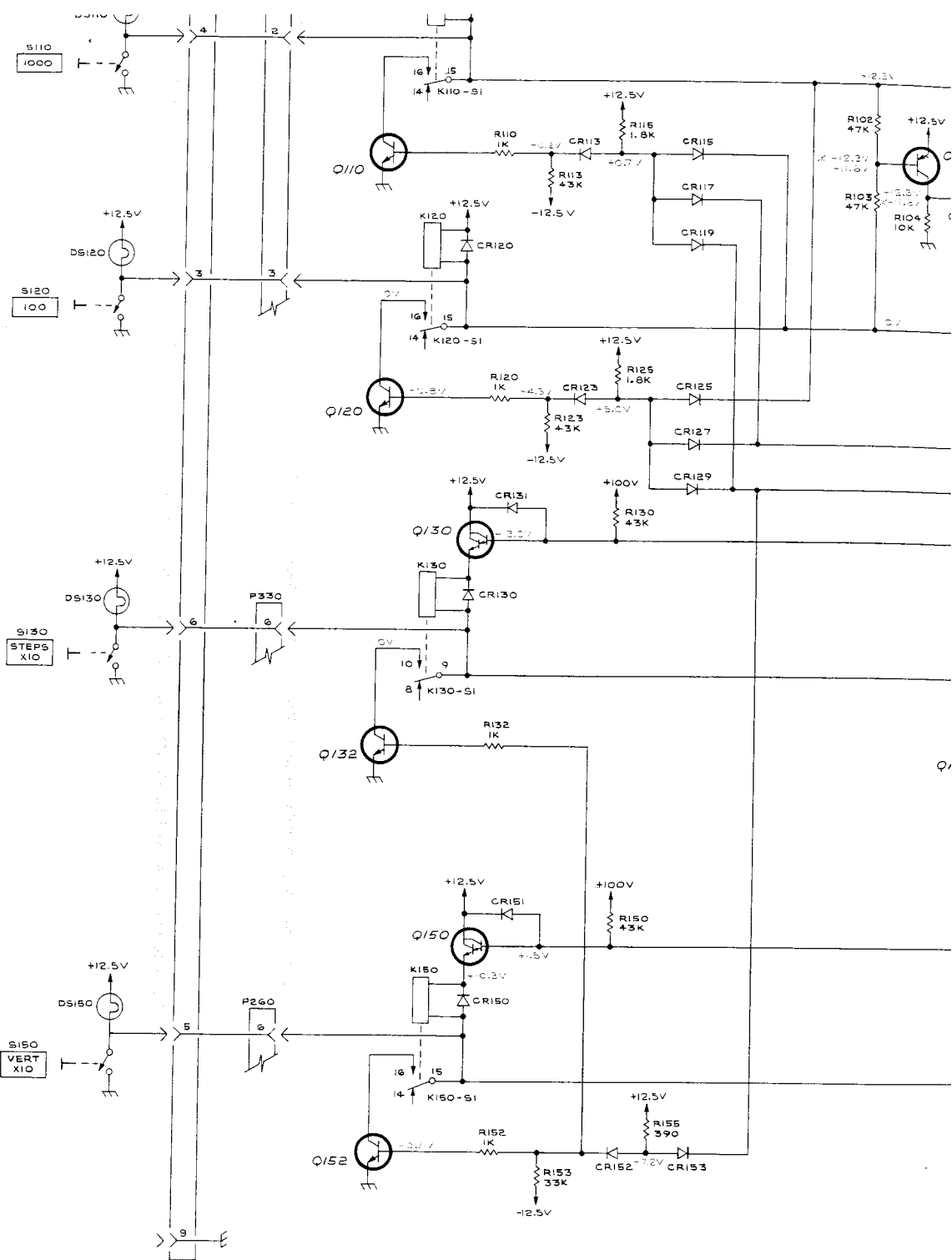

PUSH SWITCH BOARD **P/O A6**

XIO BUTTON PRESSED

REFERENCE DIAGRAMS

② BASE PULSE AMPLIFIER

NOTE:
SEE TABLE 7-1 AT THE BEGINNING
OF THIS SECTION FOR THE
LOCATIONS OF THE RELAY CONTACTS

+

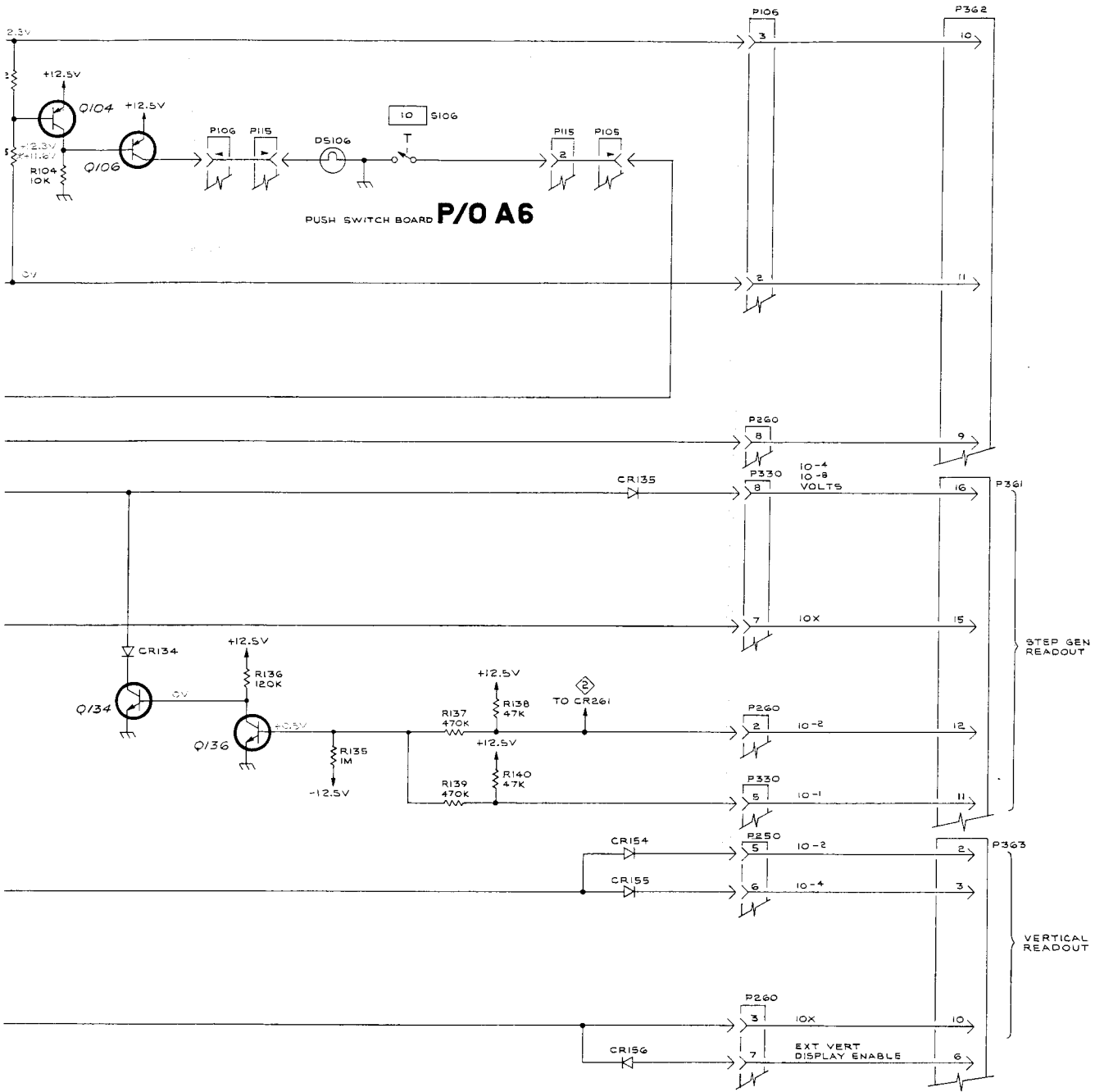

MAIN BOARD P/O A1

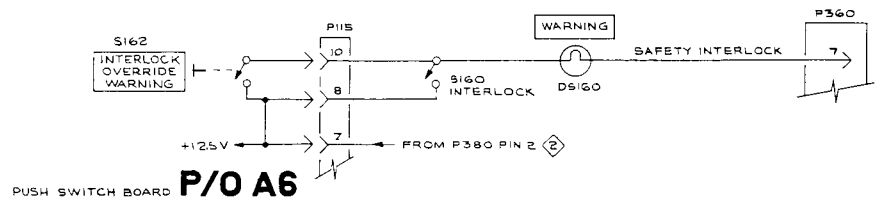

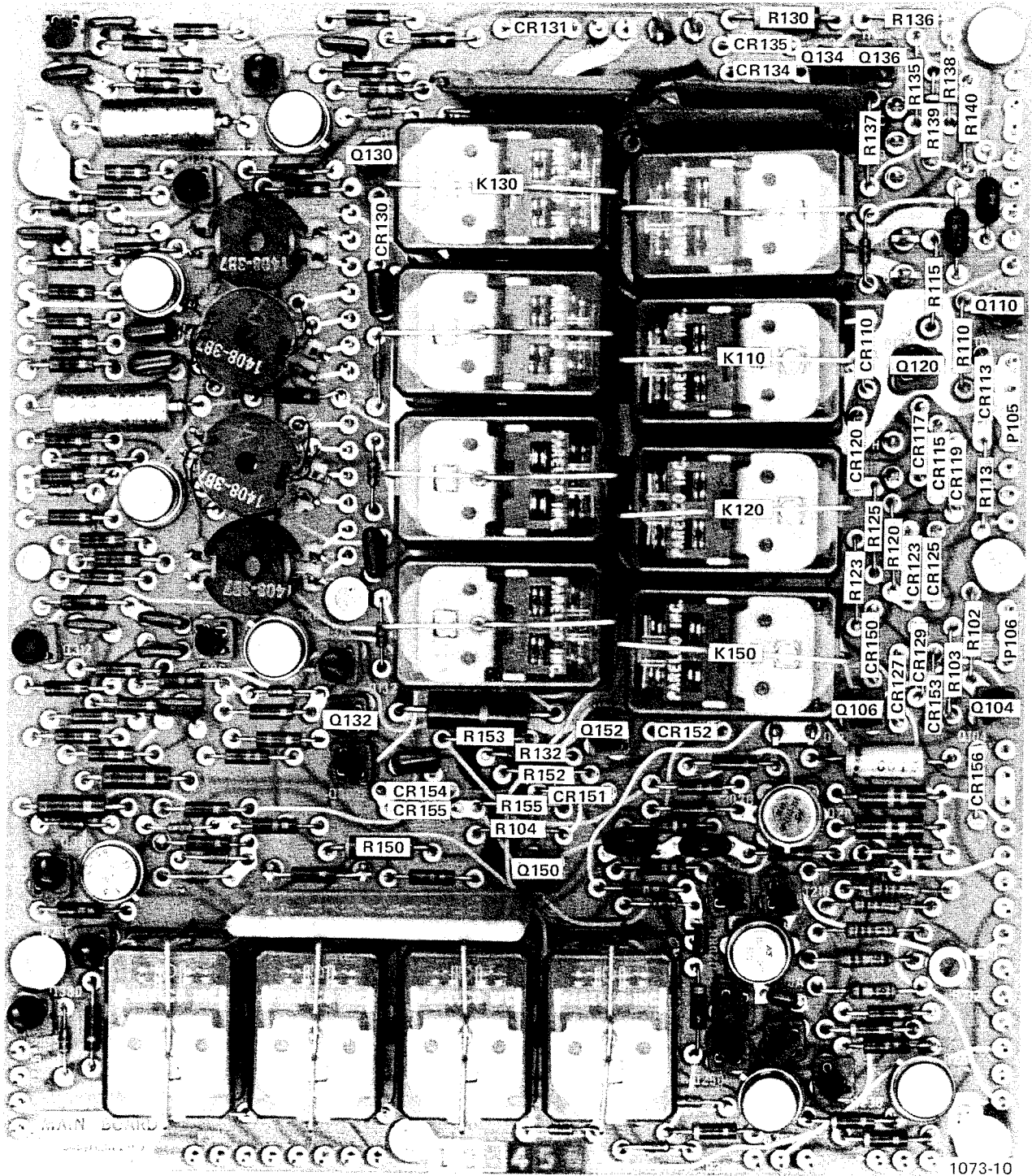

MAIN BOARD A1

REV JAN 1982

+

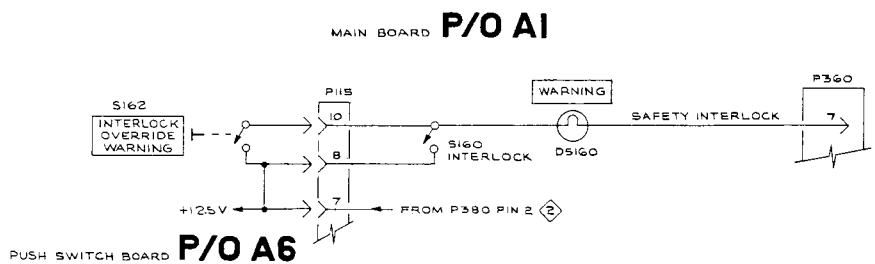
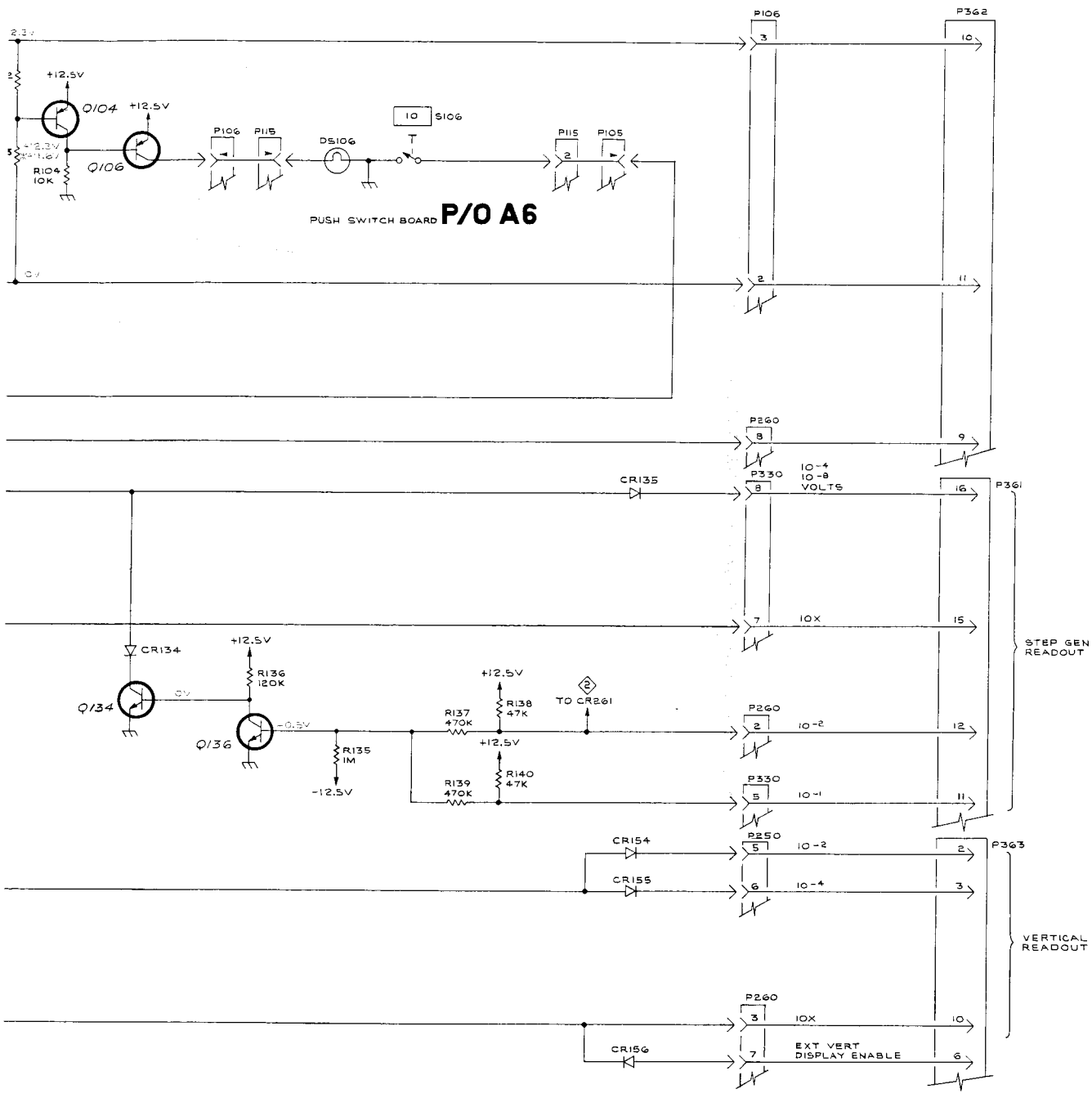

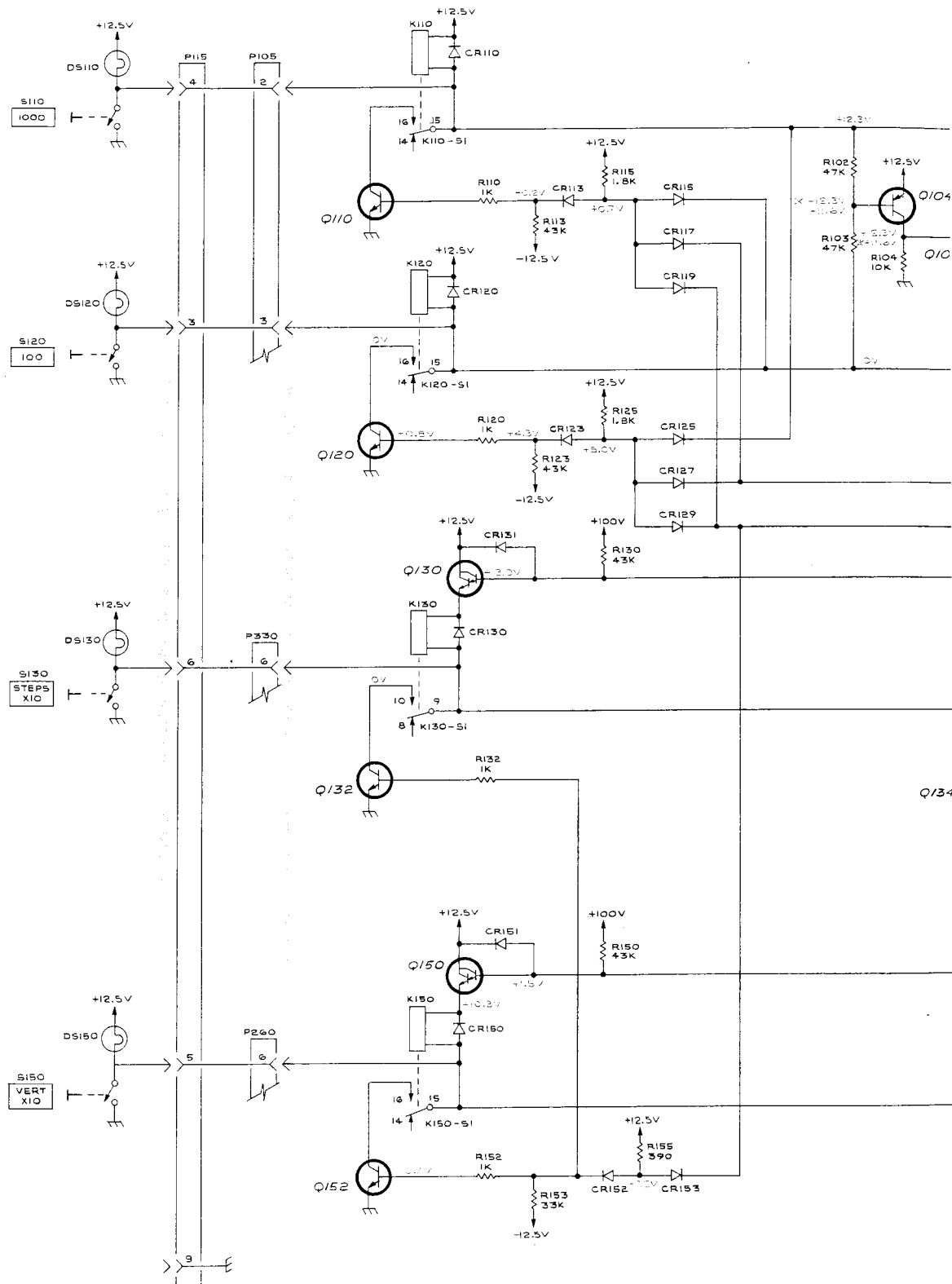

PUSH SWITCH BOARD **P/O A6**

NO CONNECTION REQUIRED

REFERENCE DIAGRAMS

⬡ BASE PULSE AMPLIFIER

NOTE:
SEE TABLE 7-1 AT THE BEGINNING
OF THIS SECTION FOR THE
LOCATIONS OF THE RELAY CONTACTS

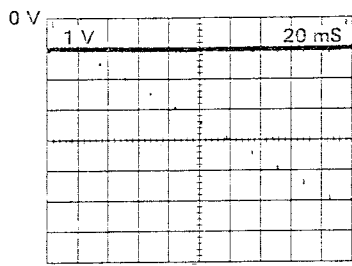

1

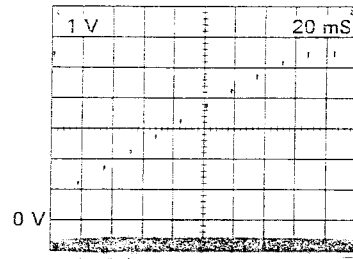

2

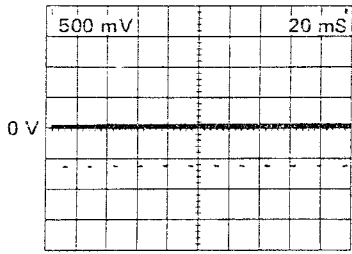

3

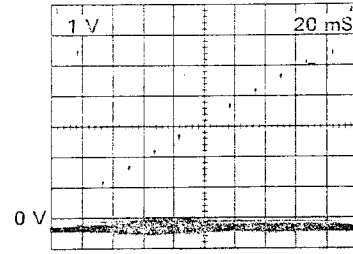

4

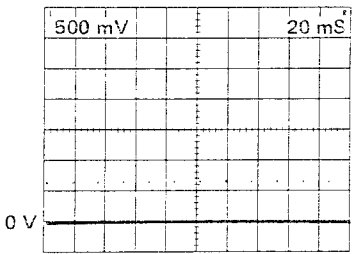

5

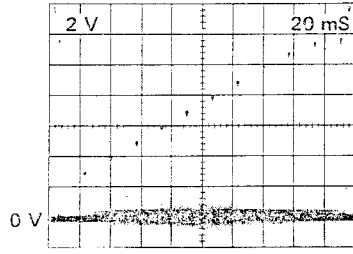

6

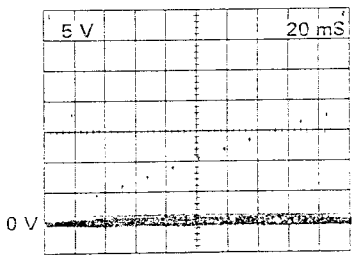

7

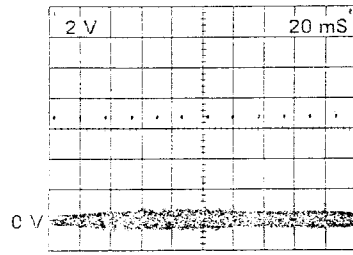

8

+

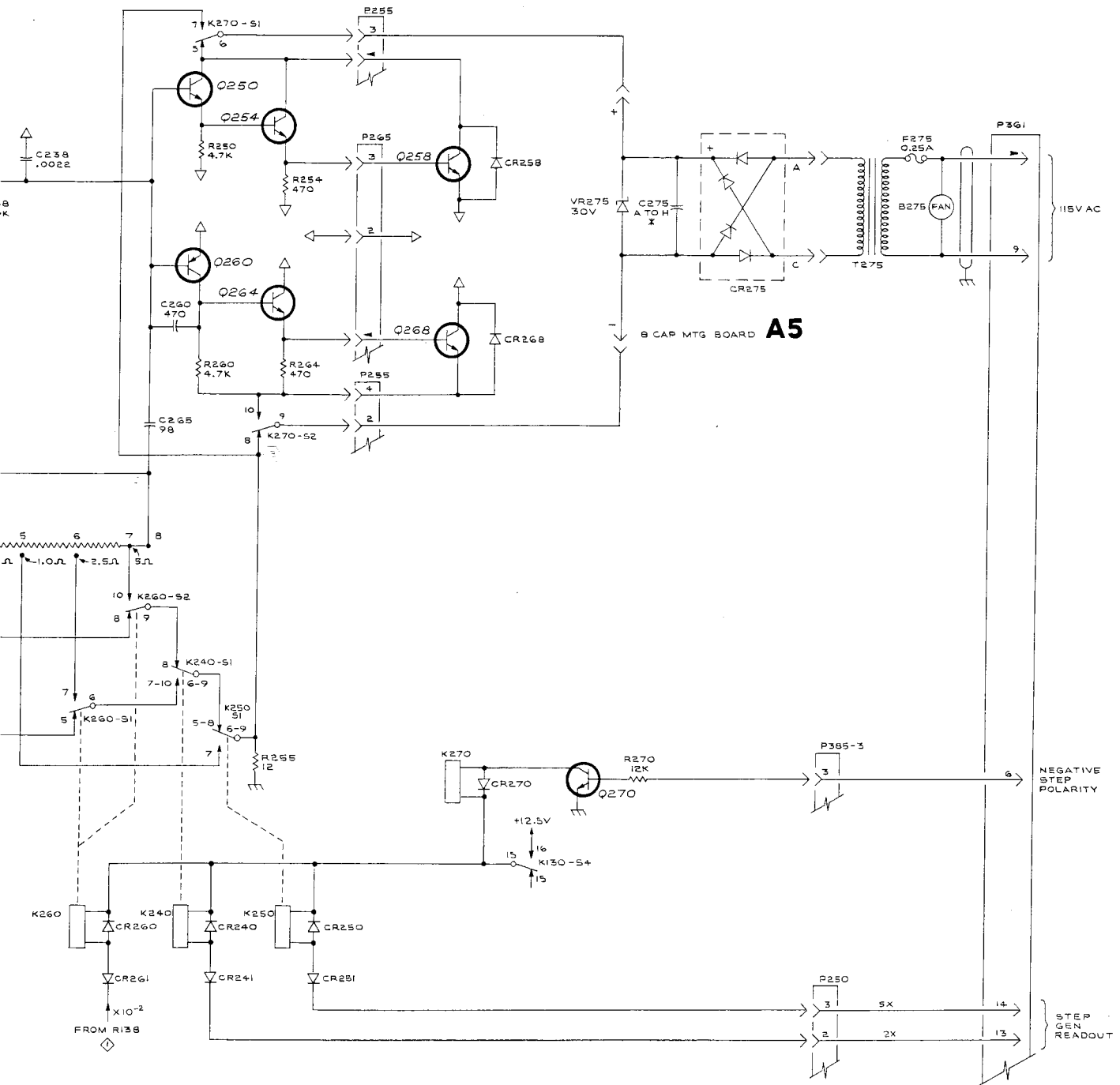

MAIN BOARD P/O AI

- NOTES:
1. SEE PARTS LIST FOR SEMICONDUCTOR TYPES
 2. X.C275 A TO H IS 8 EACH 420μF
 3. ∇ CONNECTED TO SAME PLACE ON CHASSIS
 4. SEE TABLE 7-1 AT THE BEGINNING OF THIS SECTION FOR THE LOCATIONS OF THE RELAY CONTACTS

- REFERENCE DIAGRAMS
- ① MODE SWITCHING
 - ② PULSED COLLECTOR SUPPLY

⑤

'A' Brn on wht
'B' Red on wht
'C' Blk on wht

'D' Yel on wht
'E' Brn on wht
'F' Grn on wht

'G' Yel on wht
'H' Vio on wht
'I' Gry on wht

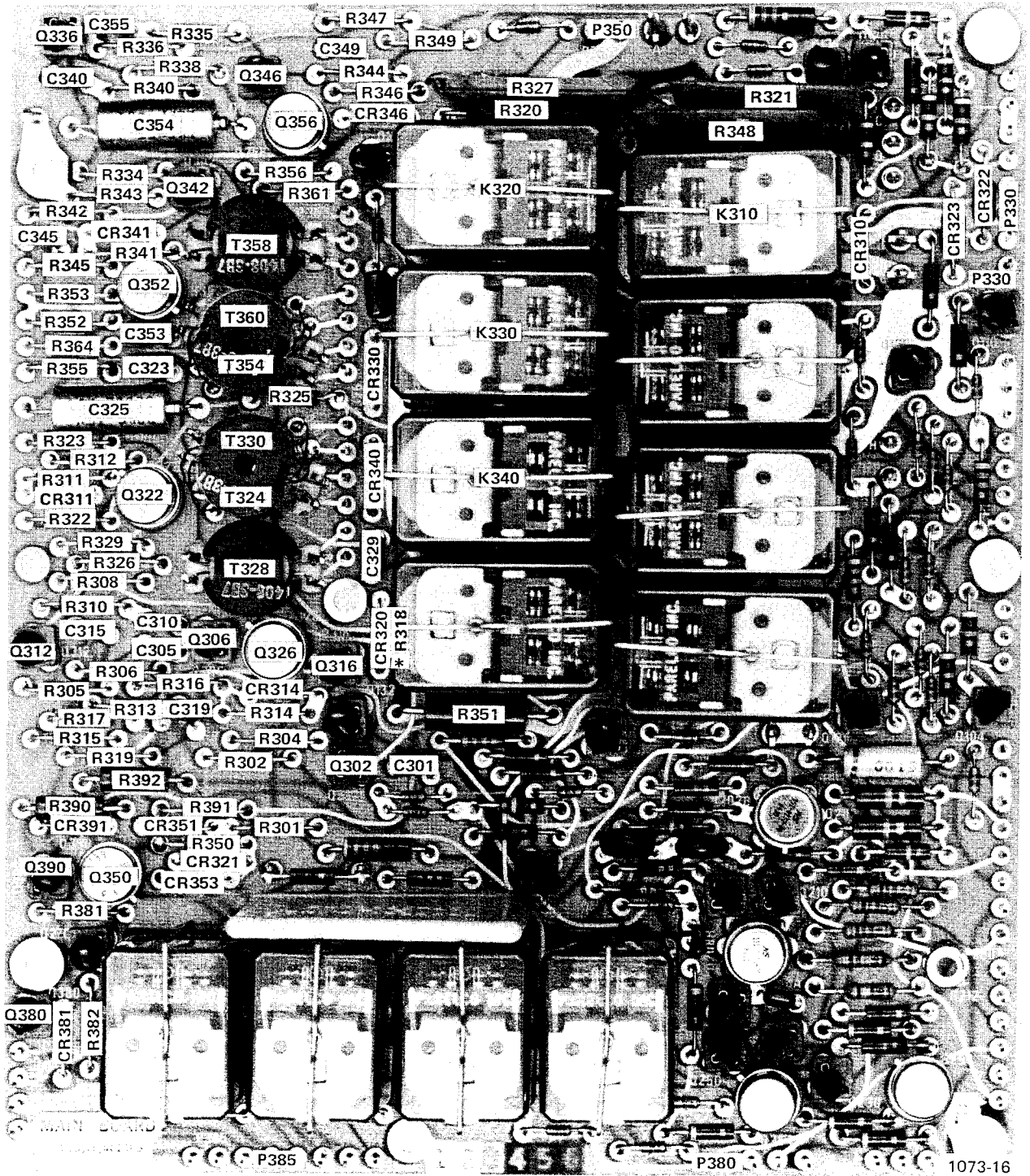

MAIN BOARD A1

REV JAN 1982

*See Parts List for serial number ranges.

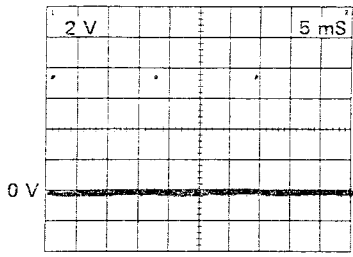

1

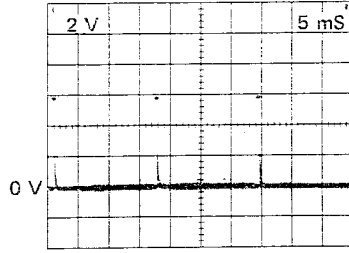

2

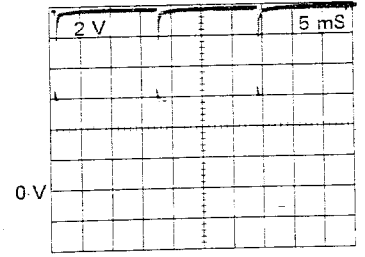

3

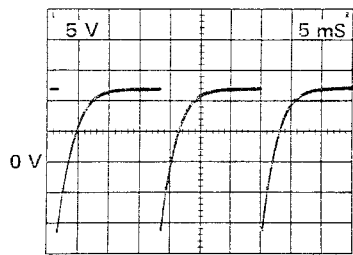

4

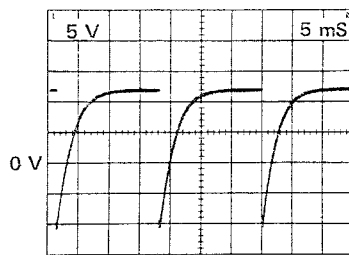

5

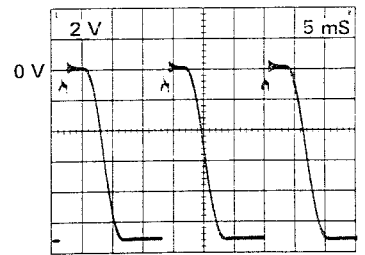

6

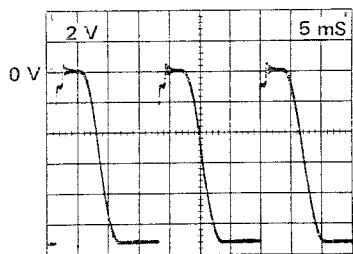

7

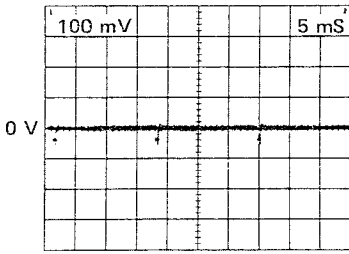

8

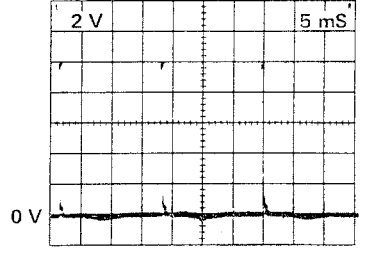

9

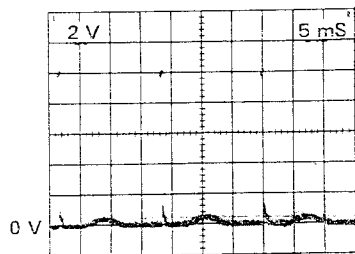

10

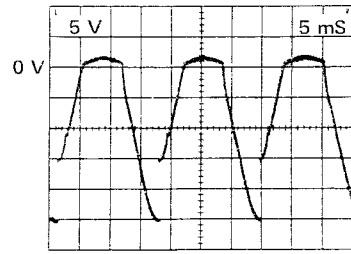

11

3

6

9

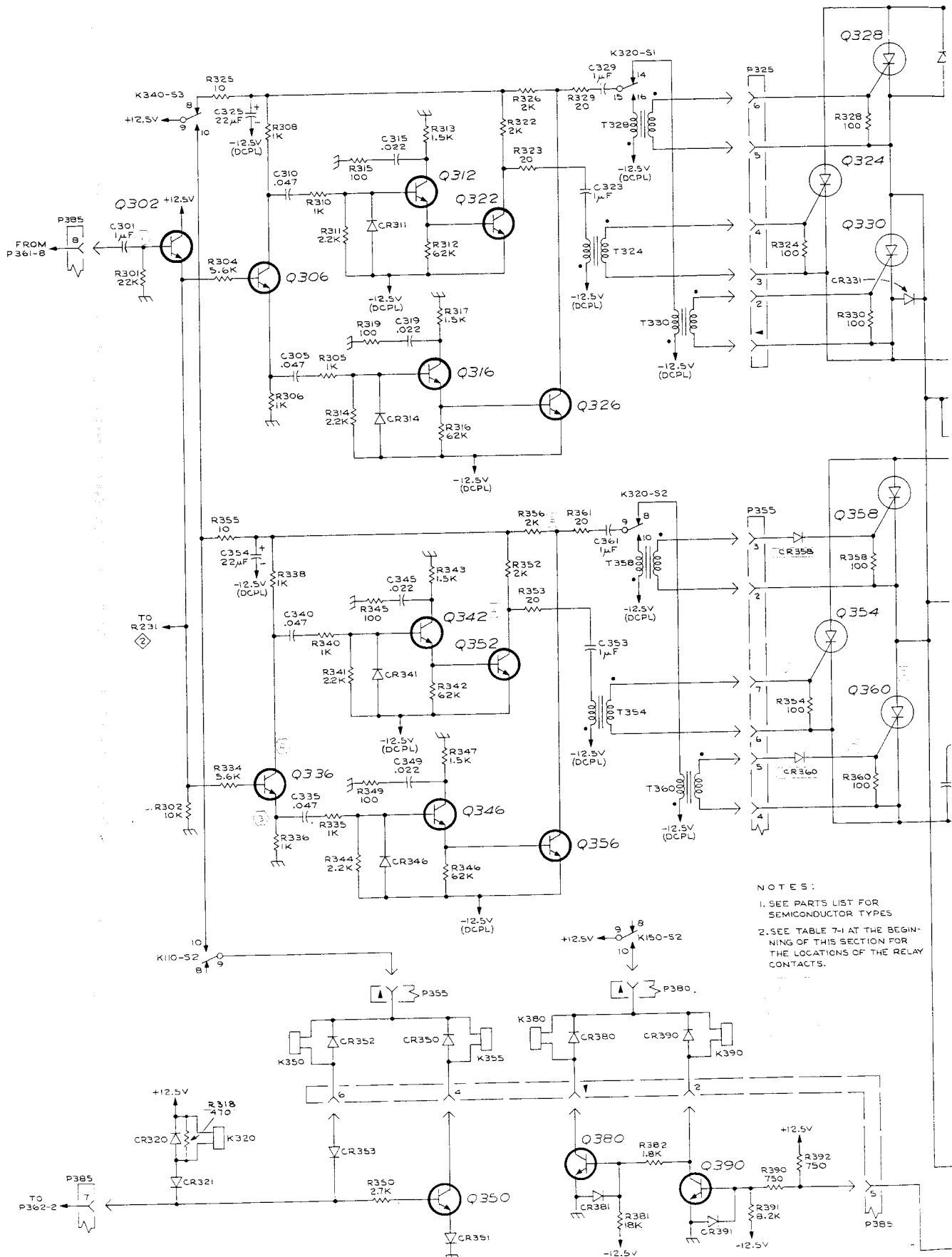

NOTES:

1. SEE PARTS LIST FOR SEMICONDUCTOR TYPES
2. SEE TABLE 7-1 AT THE BEGINNING OF THIS SECTION FOR THE LOCATIONS OF THE RELAY CONTACTS.

P/O AI MAIN BOARD

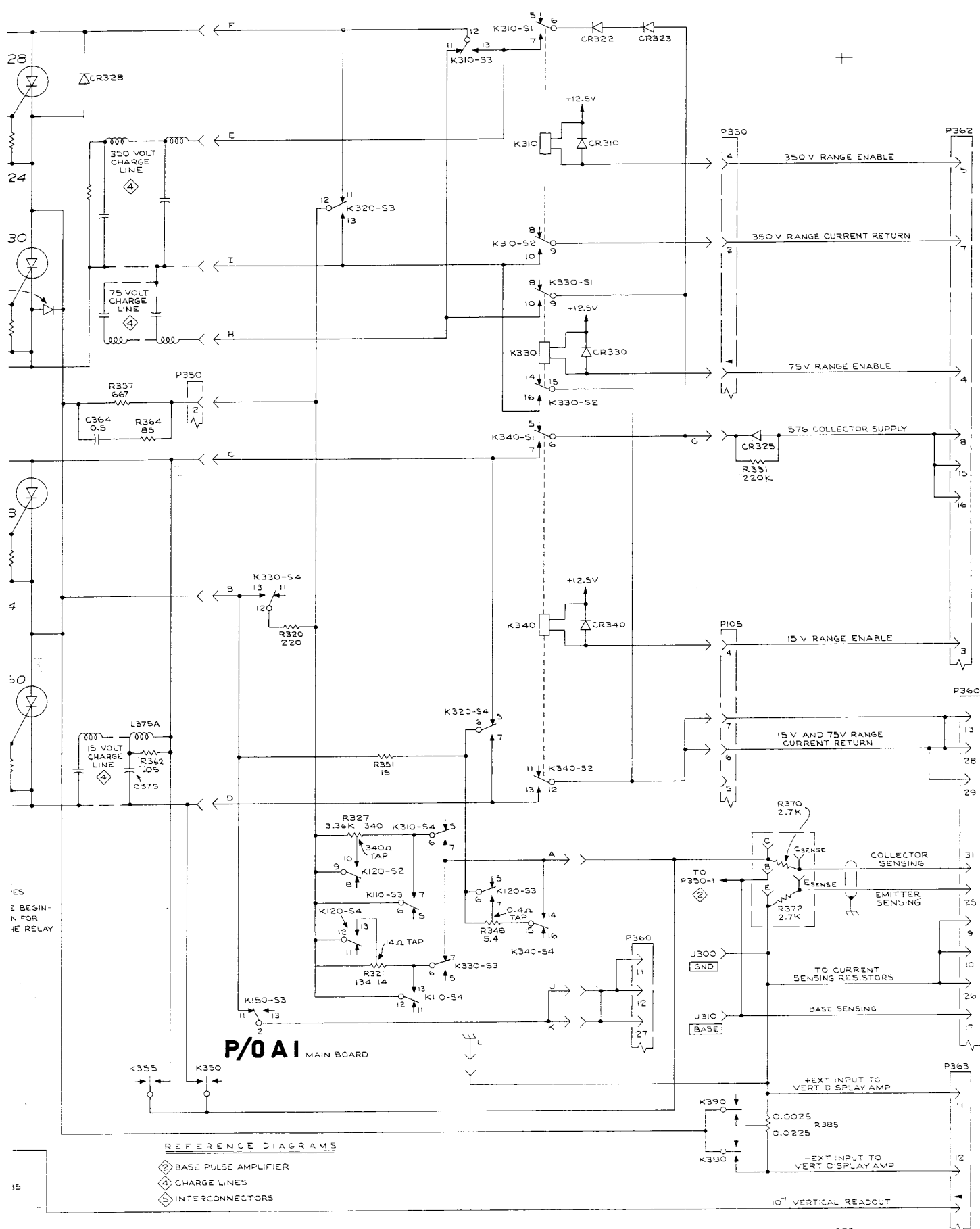

REFERENCE DIAGRAMS

- ② BASE PULSE AMPLIFIER
- ④ CHARGE LINES
- ⑤ INTERCONNECTORS

FIG. 1 FRONT, REAR &
ADAPTER CHASSIS

+

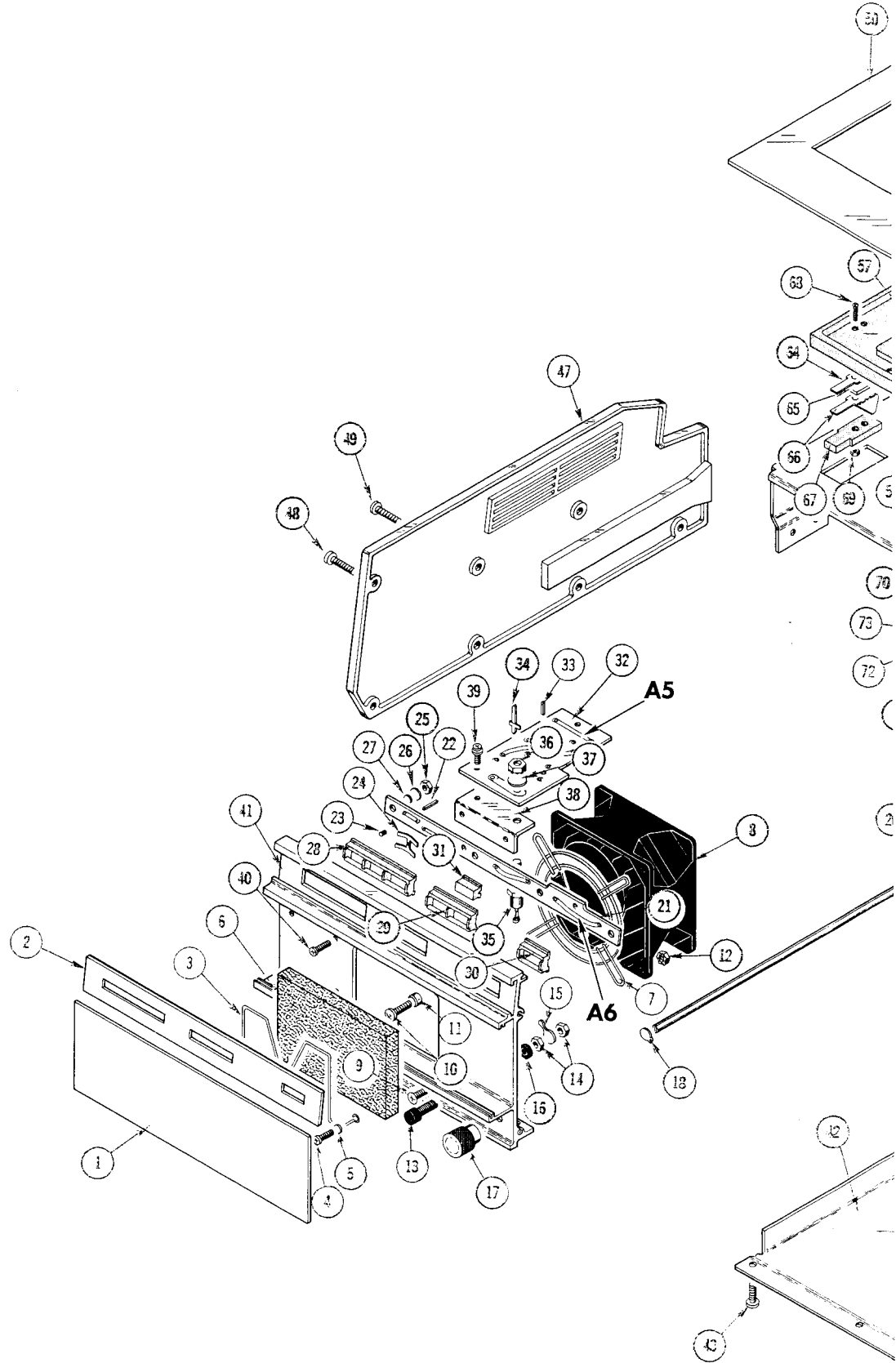

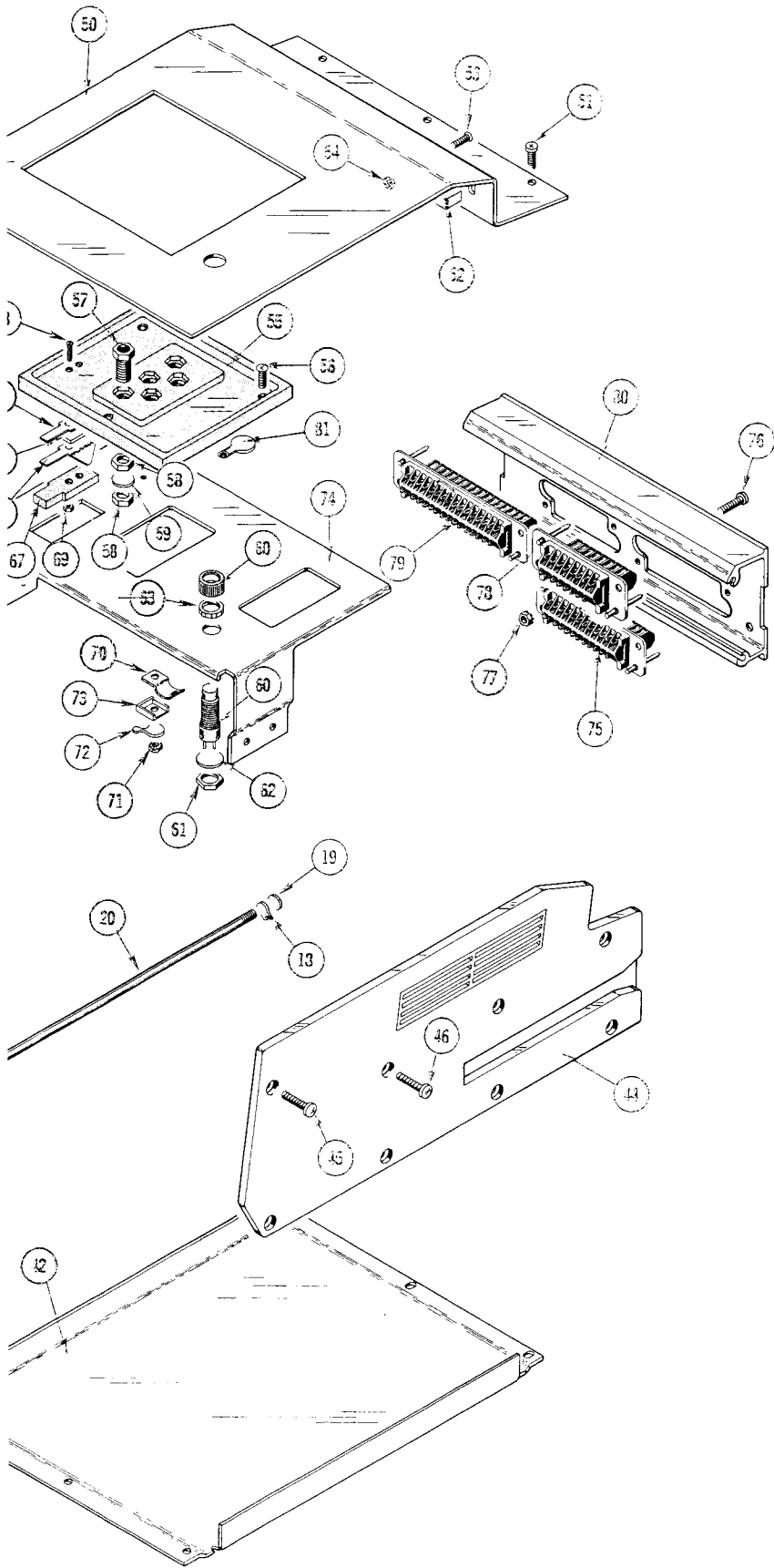

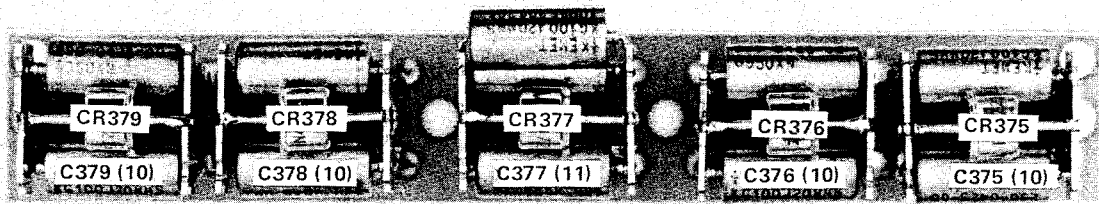

15 VOLT LINE A3

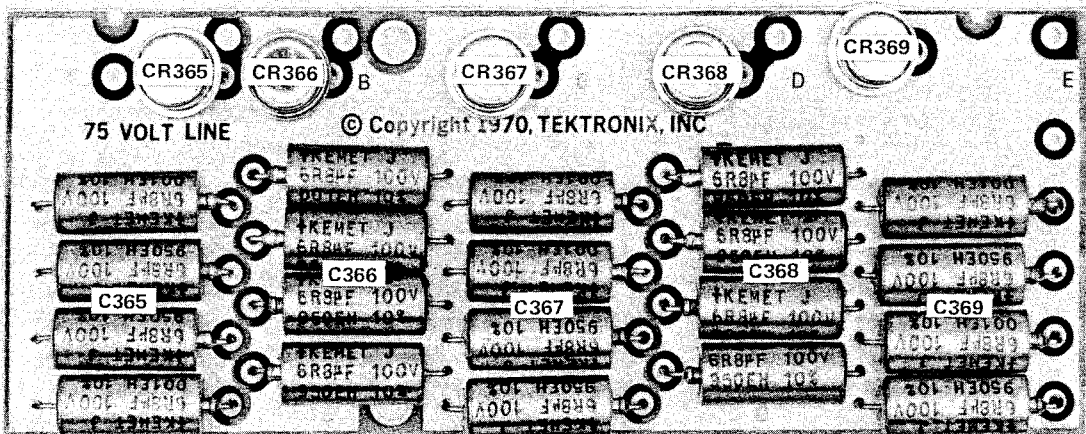

75 VOLT LINE A4

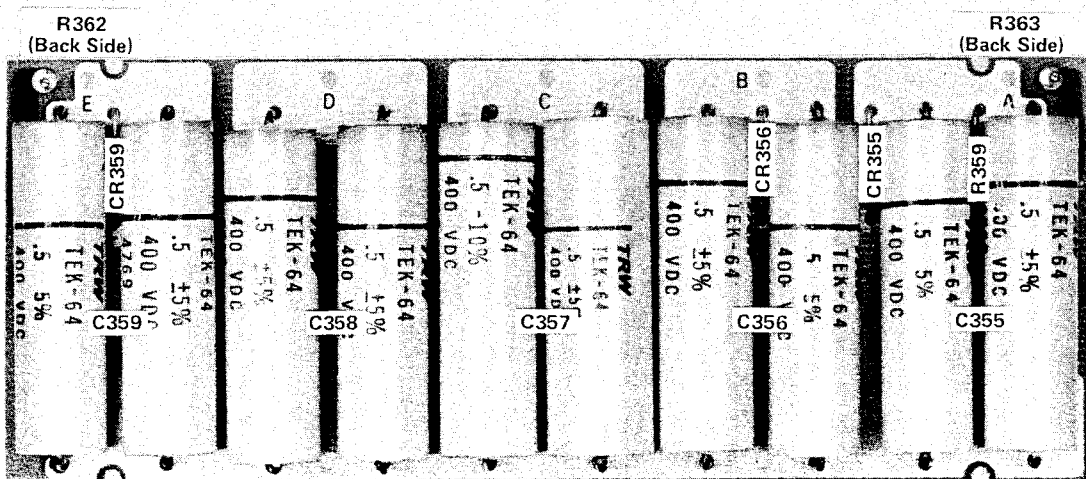

350 VOLT LINE A2

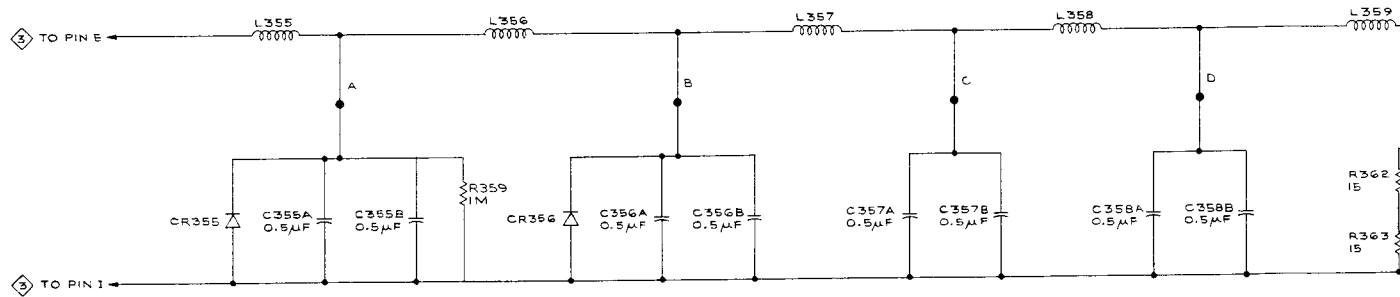
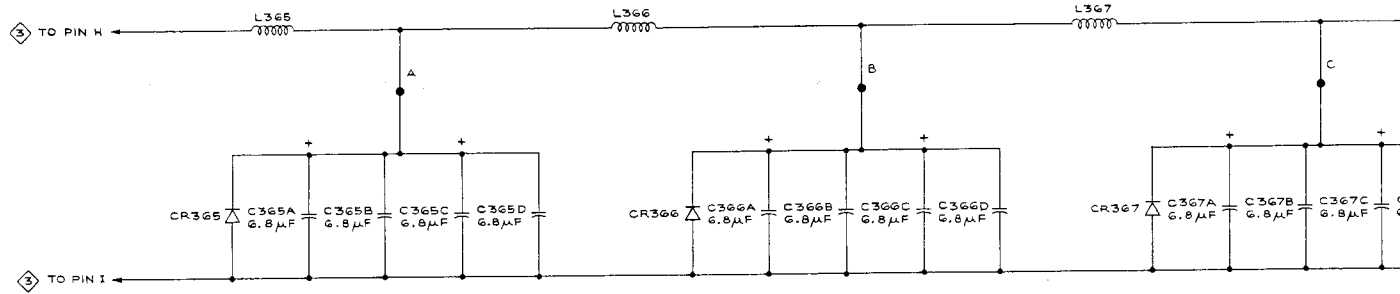
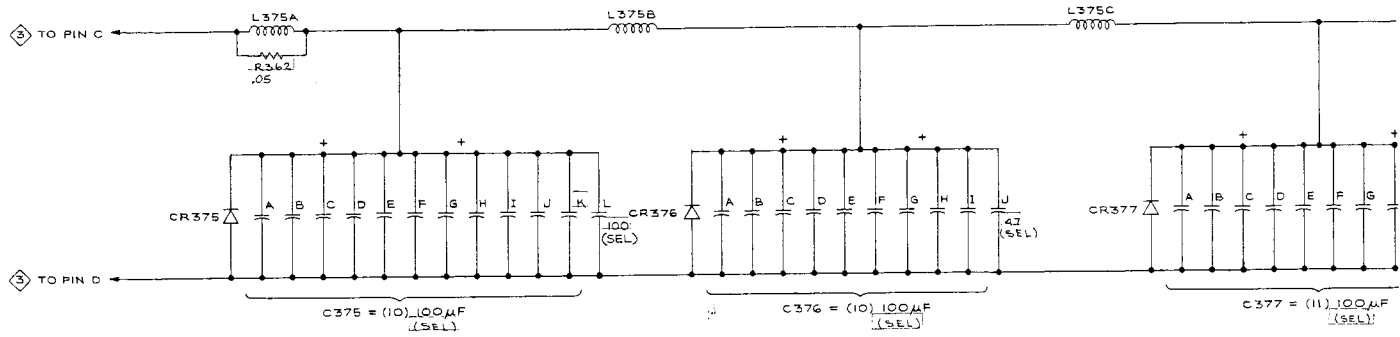

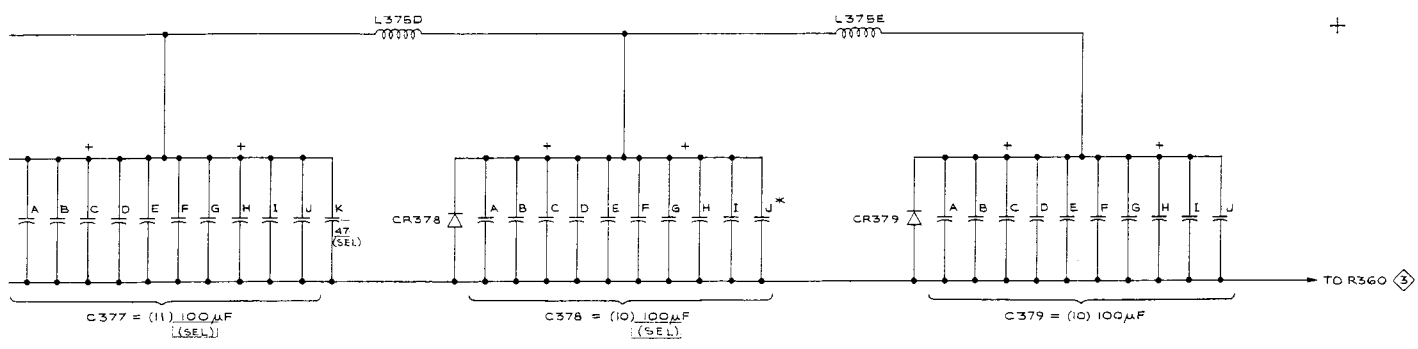

15 VOLT LINE BOARD **A3**

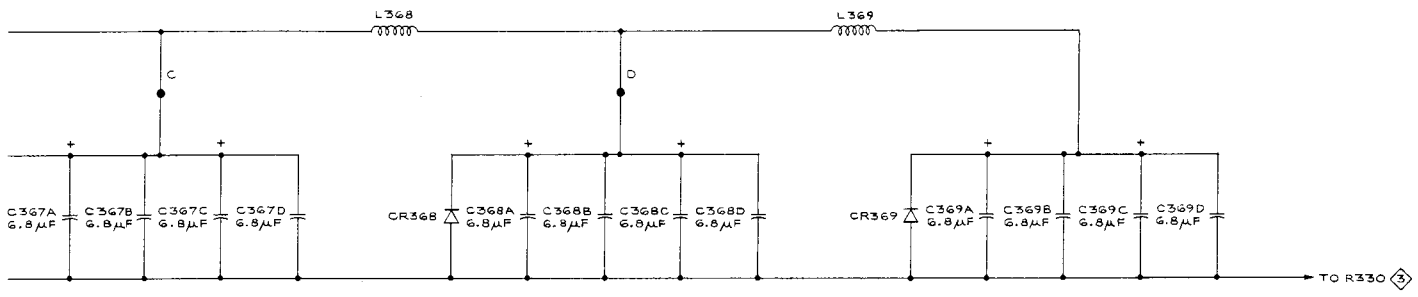

75 VOLT LINE BOARD **A4**

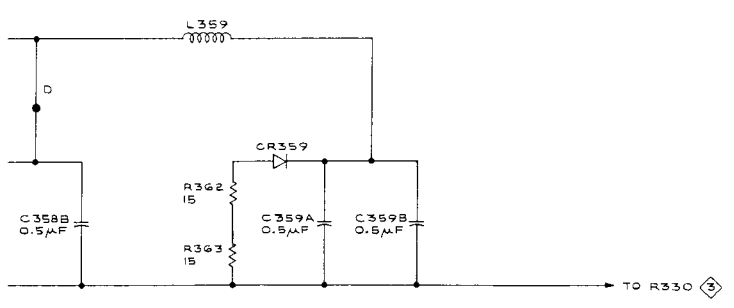

350 VOLT LINE BOARD **A2**

* USED IN 15 VOLT CHARGE LINE WHEN REQUIRED

SEE PARTS LIST FOR EARLIER VALUES AND SERIAL NUMBER RANGES OF PARTS OUTLINED OR DESIGNATED IN BLUE.

REFERENCE DIAGRAM

③ PULSED COLLECTOR SUPPLY

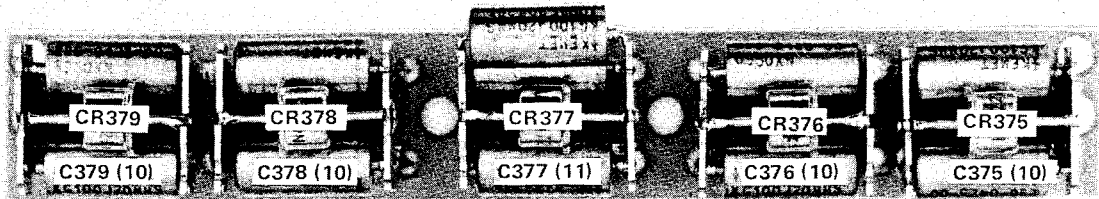

15 VOLT LINE A3

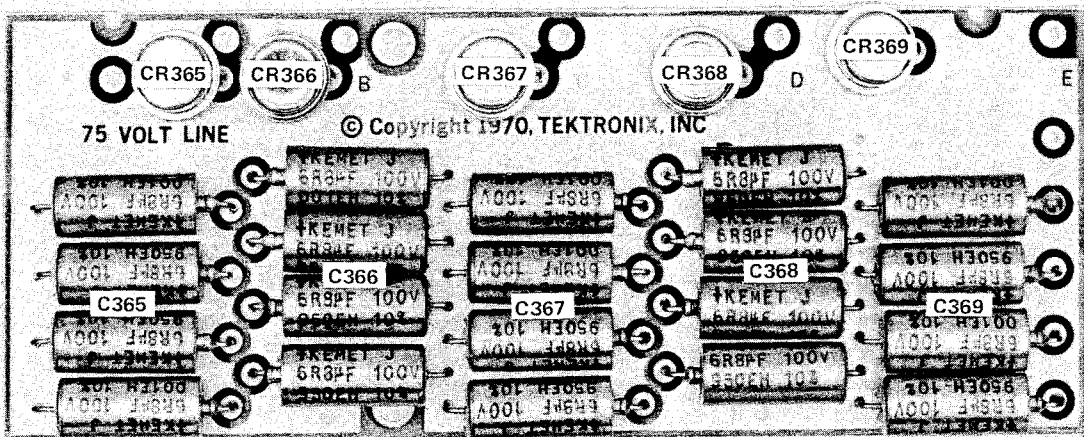

75 VOLT LINE A4

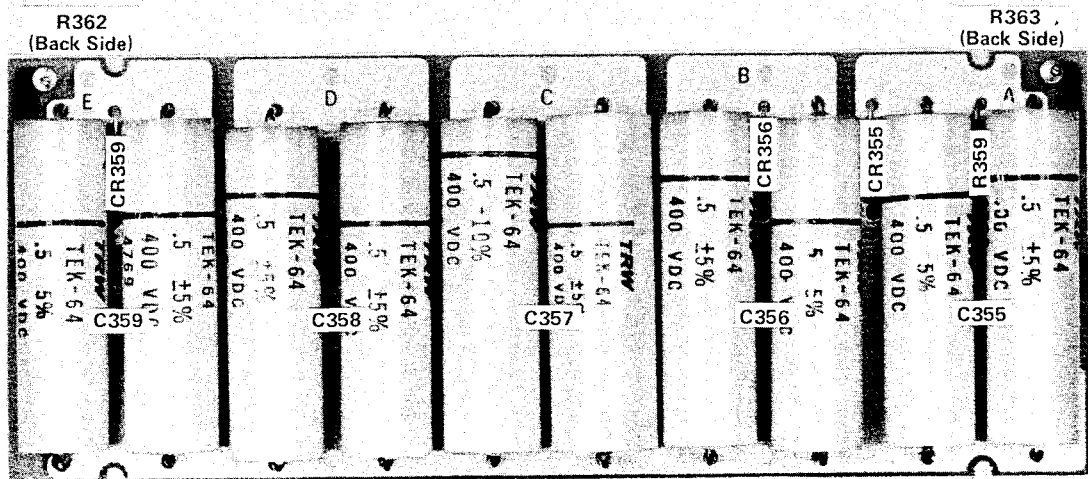

350 VOLT LINE A2

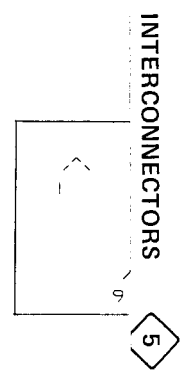
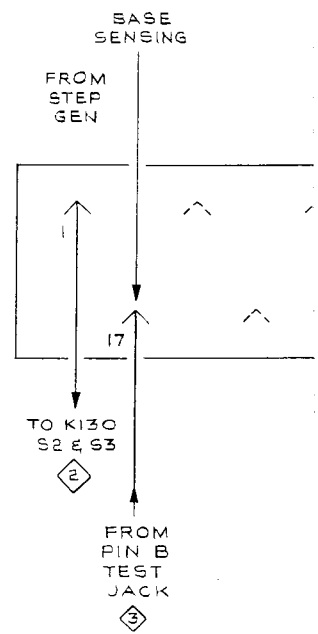

C P T

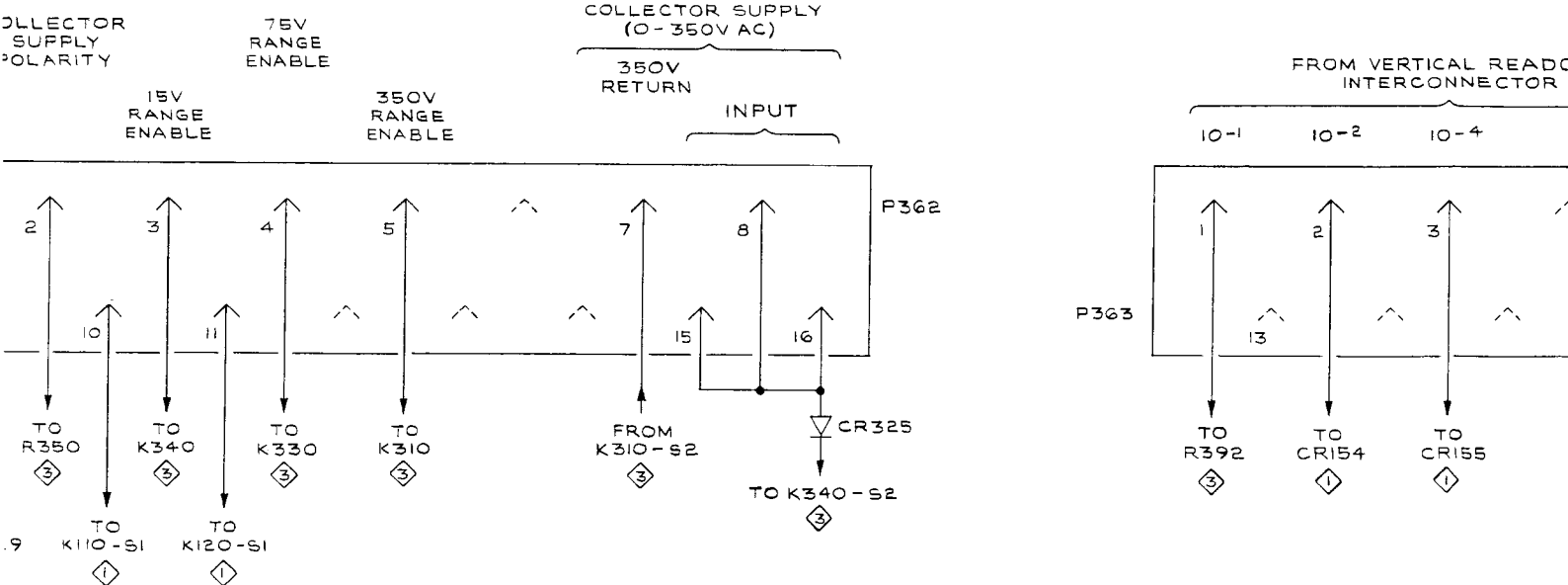
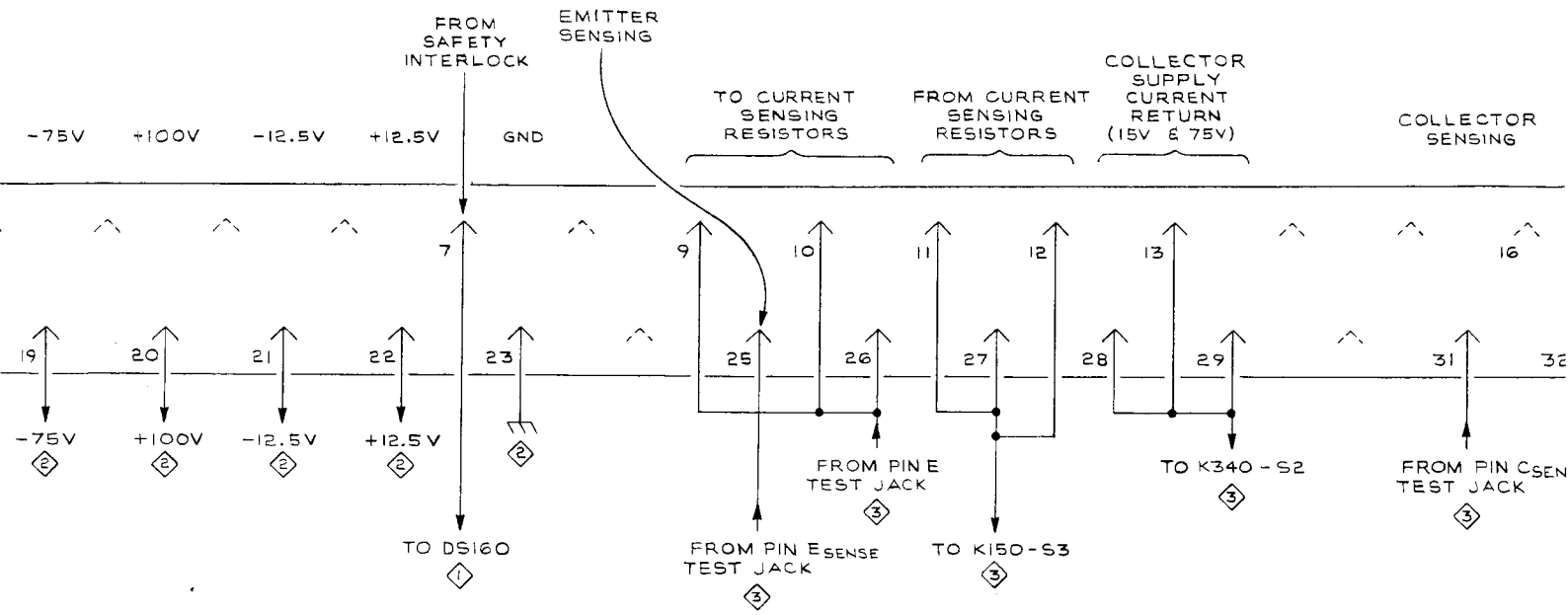

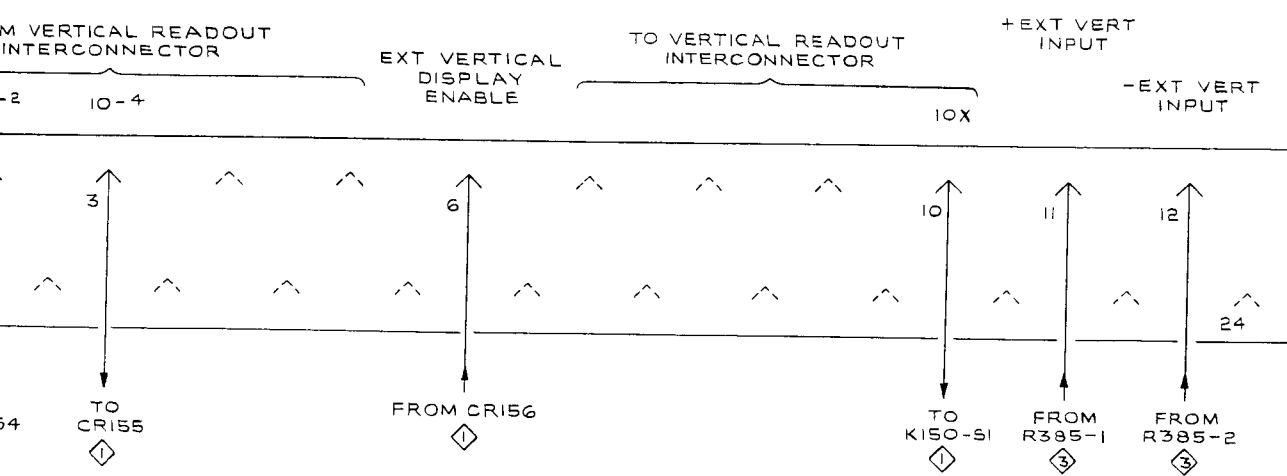
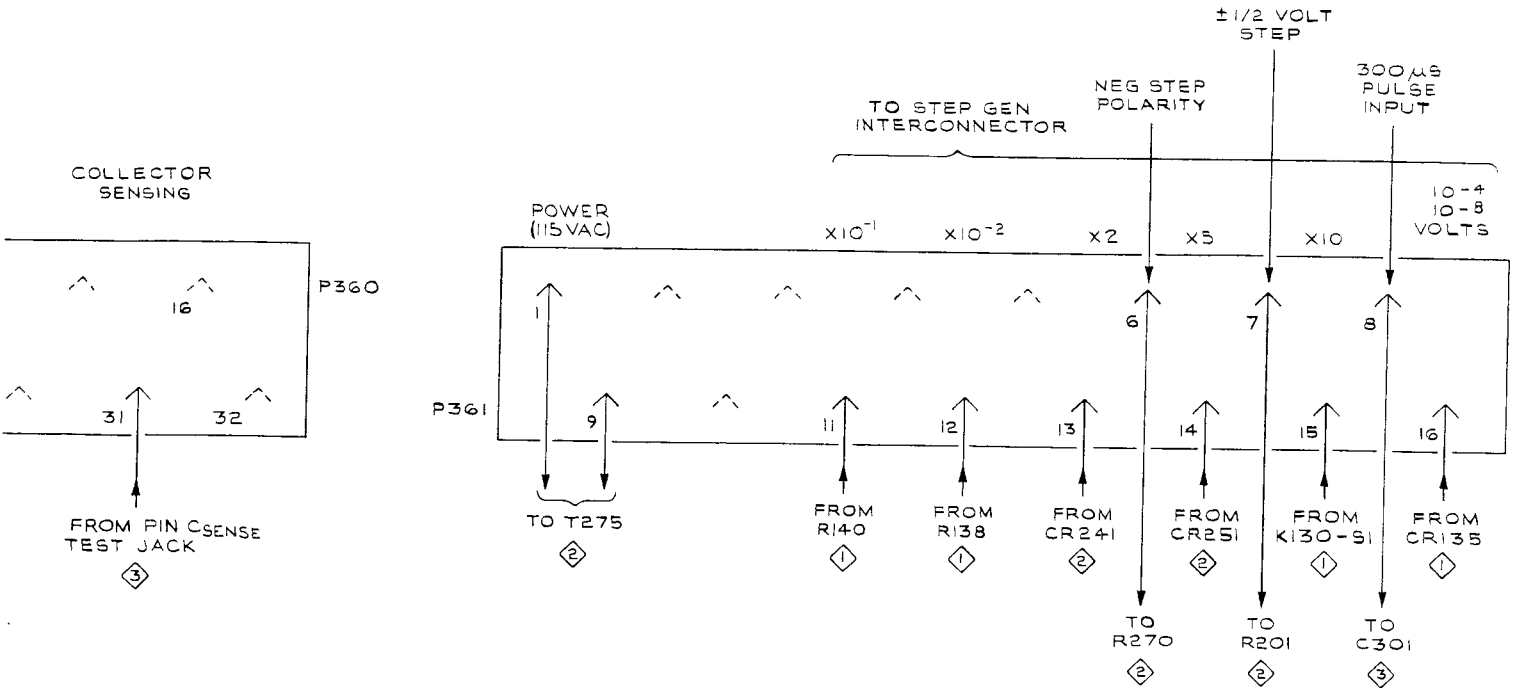

REFERENCE DIAGRAMS

- ① MODE SWITCHING
- ② BASE PULSE AMPLIFIER
- ③ PULSED COLLECTOR SUPPLY

REPLACEABLE MECHANICAL PARTS

PARTS ORDERING INFORMATION

Replacement parts are available from or through your local Tektronix, Inc. Field Office or representative.

Changes to Tektronix instruments are sometimes made to accommodate improved components as they become available, and to give you the benefit of the latest circuit improvements developed in our engineering department. It is therefore important, when ordering parts, to include the following information in your order: Part number, instrument type or number, serial number, and modification number if applicable.

If a part you have ordered has been replaced with a new or improved part, your local Tektronix, Inc. Field Office or representative will contact you concerning any change in part number.

Change information, if any, is located at the rear of this manual.

SPECIAL NOTES AND SYMBOLS

X000 Part first added at this serial number
00X Part removed after this serial number

FIGURE AND INDEX NUMBERS

Items in this section are referenced by figure and index numbers to the illustrations.

INDENTATION SYSTEM

This mechanical parts list is indented to indicate item relationships. Following is an example of the indentation system used in the description column.

```

1 2 3 4 5           Name & Description
Assembly and/or Component
Attaching parts for Assembly and/or Component
    ---*---
Detail Part of Assembly and/or Component
Attaching parts for Detail Part
    ---*---
Parts of Detail Part
Attaching parts for Parts of Detail Part
    ---*---

```

Attaching Parts always appear in the same indentation as the item it mounts, while the detail parts are indented to the right. Indented items are part of, and included with, the next higher indentation. The separation symbol ---*--- indicates the end of attaching parts.

Attaching parts must be purchased separately, unless otherwise specified.

ITEM NAME

In the Parts List, an Item Name is separated from the description by a colon (:). Because of space limitations, an Item Name may sometimes appear as incomplete. For further Item Name identification, the U.S. Federal Cataloging Handbook H6-1 can be utilized where possible.

ABBREVIATIONS

"	INCH	ELCTRN	ELECTRON	IN	INCH	SE	SINGLE END
#	NUMBER SIZE	ELEC	ELECTRICAL	INCAND	INCANDESCENT	SECT	SECTION
ACTR	ACTUATOR	ELCTLT	ELECTROLYTIC	INSUL	INSULATOR	SEMICOND	SEMICONDUCTOR
ADPTR	ADAPTER	ELEM	ELEMENT	INTL	INTERNAL	SHLD	SHIELD
ALIGN	ALIGNMENT	EPL	ELECTRICAL PARTS LIST	LPHLDR	LAMPHOLDER	SHLDR	SHOULDERED
AL	ALUMINUM	EQPT	EQUIPMENT	MACH	MACHINE	SKT	SOCKET
ASSEM	ASSEMBLED	EXT	EXTERNAL	MECH	MECHANICAL	SL	SLIDE
ASSY	ASSEMBLY	FIL	FILLISTER HEAD	MTG	MOUNTING	SLFLKG	SELF-LOCKING
ATTEN	ATTENUATOR	FLEX	FLEXIBLE	NIP	NIPPLE	SLVG	SLEEVING
AWG	AMERICAN WIRE GAGE	FLH	FLAT HEAD	NON WIRE	NOT WIRE WOUND	SPR	SPRING
BD	BOARD	FLTR	FILTER	OBD	ORDER BY DESCRIPTION	SQ	SQUARE
BRKT	BRACKET	FR	FRAME or FRONT	OD	OUTSIDE DIAMETER	SST	STAINLESS STEEL
BRS	BRASS	FSTNR	FASTENER	OVH	OVAL HEAD	STL	STEEL
BRZ	BRONZE	FT	FOOT	PH BRZ	PHOSPHOR BRONZE	SW	SWITCH
BSHG	BUSHING	FXD	FIXED	PL	PLAIN or PLATE	T	TUBE
CAB	CABINET	GSKT	GASKET	PLSTC	PLASTIC	TERM	TERMINAL
CAP	CAPACITOR	HDL	HANDLE	PN	PART NUMBER	THD	THREAD
CER	CERAMIC	HEX	HEXAGON	PNH	PAN HEAD	THK	THICK
CHAS	CHASSIS	HEX HD	HEXAGONAL HEAD	PWR	POWER	TNSN	TENSION
CKT	CIRCUIT	HEX SOC	HEXAGONAL SOCKET	RCPT	RECEPTACLE	TPG	TAPPING
COMP	COMPOSITION	HLCPS	HELICAL COMPRESSION	RES	RESISTOR	TRH	TRUSS HEAD
CONN	CONNECTOR	HLEXT	HELICAL EXTENSION	RGD	RIGID	V	VOLTAGE
COV	COVER	HV	HIGH VOLTAGE	RLF	RELIEF	VAR	VARIABLE
CPLG	COUPLING	IC	INTEGRATED CIRCUIT	RTNR	RETAINER	W/	WITH
CRT	CATHODE RAY TUBE	ID	INSIDE DIAMETER	SCH	SOCKET HEAD	WSHR	WASHER
DEG	DEGREE	IDENT	IDENTIFICATION	SCOPE	OSCILLOSCOPE	XFMR	TRANSFORMER
DWR	DRAWER	IMPLR	IMPELLER	SCR	SCREW	XSTR	TRANSISTOR

CROSS INDEX—MFR. CODE NUMBER TO MANUFACTURER

Mfr. Code	Manufacturer	Address	City, State, Zip
00779	AMP, INC.	P O BOX 3608	HARRISBURG, PA 17105
02107	SPARTA MANUFACTURING COMPANY	ROUTE NO. 2, BOX 128	DOVER, OH 44622
02660	BUNKER RAMO CORP., CONNECTOR DIVISION	2801 S 25TH AVENUE	BROADVIEW, IL 60153
07707	USM CORP., USM FASTENER DIV.	510 RIVER RD.	SHELTON, CT 06484
08530	RELIANCE MICA CORP.	342-39TH ST.	BROOKLYN, NY 11232
12300	POTTER AND BRUMFIELD, DIV. AMF CANADA LTD.	52 ROYAL ROAD, P O BOX 698	GUELPH, ONTARIO, CANADA
12327	FREEWAY CORPORATION	9301 ALLEN DRIVE	CLEVELAND, OH 44125
18680	HIGHLAND MFG. CO., THE DIV. OF BUELL INDUSTRIES, INC.	1240 WOLCOTT STREET	WATERBURY, CT 06720
22526	BERG ELECTRONICS, INC.	YOUK EXPRESSWAY	NEW CUMBERLAND, PA 17070
23936	PAMOTOR DIV., WILLIAM J PURDY COMPANY	770 AIRPORT BLVD.	BURLINGAME, CA 94010
26365	GRIES REPRODUCER CO., DIV. OF COATS AND CLARK, INC.	125 BEECHWOOD AVE.	NEW ROCHELLE, NY 10802
56878	STANDARD PRESSED STEEL COMPANY	BENSON EAST	JENKINTOWN, PA 19046
71785	TRW, CINCH CONNECTORS	1501 MORSE AVENUE	ELK GROVE VILLAGE, IL 60007
73743	FISCHER SPECIAL MFG. CO.	446 MORGAN ST.	CINCINNATI, OH 45206
74445	HOLO-KROME CO.	31 BROOK ST. WEST	HARTFORD, CT 06110
74921	ITEN FIBRE CO.,	4001 BENEFIT AVE., P O BOX 9	ASHTABULA, OH 44004
74970	JOHNSON, E. F., CO.	299 10TH AVE. S. W.	WASECA, MN 56093
75915	LITTELFUSE, INC.	800 E. NORTHWEST HWY	DES PLAINES, IL 60016
77342	AMF INC., POTTER AND BRUMFIELD DIV.	200 RICHLAND CREEK DRIVE	PRINCETON, IN 47670
78189	ILLINOIS TOOL WORKS, INC. SHAKEPROOF DIVISION	ST. CHARLES ROAD	ELGIN, IL 60120
78471	TILLEY MFG. CO.	900 INDUSTRIAL RD.	SAN CARLOS, CA 94070
78584	STEWART STAMPING CORP.	630 CENTRAL PARK AVE.	YONKERS, NY 10704
79136	WALDES, KOHINOOR, INC.	47-16 AUSTEL PLACE	LONG ISLAND CITY, NY 11101
80009	TEKTRONIX, INC.	P O BOX 500	BEAVERTON, OR 97077
83309	ELECTRICAL SPECIALITY CO., SUBSIDIARY OF BELDEN CORP.	213 E. HARRIS AVE. SOUTH	SAN FRANCISCO, CA 94080
83385	CENTRAL SCREW CO.	2530 CRESCENT DR.	BROADVIEW, IL 60153
86928	SEASTROM MFG. COMPANY, INC.	701 SONORA AVENUE	GLENDALE, CA 91201
88245	LITTON SYSTEMS, INC., USECO DIV.	13536 SATICOY ST.	VAN NUYS, CA 91409
91886	MALCO A MICRODOT CO.	12 PROGRESS DRIVE	MONTGOMERYVILLE, PA 18936
95987	WECKESSER CO., INC.	4444 WEST IRVING PARK RD.	CHICAGO, IL 60641

Replaceable Mechanical Parts—176

Fig. & Index No.	Tektronix Part No.	Serial/Model No. Eff Dscont	Qty	1	2	3	4	5	Name & Description	Mfr Code	Mfr Part Number
1-1	333-1325-00		1						PANEL, FRONT: LOWER	80009	333-1325-00
-2	333-1324-00		1						PANEL, FRONT: UPPER	80009	333-1324-00
-3	344-0215-00		1						CLIP, AIR FLTR: SS (ATTACHING PARTS)	80009	344-0215-00
-4	211-0007-00		2						SCREW, MACHINE: 4-40 X 0.188 INCH, PNH STL	83385	OBD
-5	210-0994-00		2						WASHER, FLAT: 0.125 ID X 0.25" OD, STL - - - * - - -	86928	5702-201-20
-6	378-0038-00		1						FILTER ELEM, AIR: 3.5 X 2.3 X 0.375	80009	378-0038-00
-7	378-0780-00		1						GRILLE, FAN: 3.182 X 3.182 INCH	80009	378-0780-00
-8	119-0215-00		1						FAN, AXIAL: 115V, 50-60 HZ, 18W (ATTACHING PARTS)	23936	8500D
-9	212-0011-00		2						SCREW, MACHINE: 8-32 X 0.750 INCH, FLH STL	83385	OBD
-10	212-0033-00		2						SCREW, MACHINE: 8-32 X 0.750 INCH, PNH STL	83385	OBD
-11	166-0030-00		4						SPACER, SLEEVE: 0.25 OD X 0.188 INCH LONG	80009	166-0030-00
-12	210-0458-00		4						NUT, PL, ASSEM WA: 8-32 X 0.344 INCH, STL - - - * - - -	83385	OBD
-13	136-0140-00		2						JACK, TIP: BANANA STYLE, CHARCOAL GRAY CA (ATTACHING PARTS)	80009	136-0140-00
-14	210-0562-00		4						NUT, PLAIN, HEX.: 0.25-40 X 0.312 INCH, BBS	73743	2X20224-402
-15	210-0223-00		2						TERMINAL, LUG: 0.25 INCH DIA, SE	86928	A313-136
-16	210-0895-00		2						WSHR, SHOULDERED: 0.375 OD X 0.105 INCH THK - - - * - - -	80009	210-0895-00
-17	366-0125-00		2						KNOB: KNURLED SECURING	80009	366-0125-00
	213-0004-00		2						. SETSCREW: 6-32 X 0.188 INCH, HEX. SOC STL	74445	OBD
-18	354-0025-00		4						RING, RETAINING: 0.181 INCH FREE ID	79136	5555-18
-19	210-0805-00		2						WASHER, FLAT: 0.204 ID X 0.438 INCH OD, STL	12327	OBD
-20	384-0774-00		2						PIN, STR, THD: 0.188 X 11.438 L, W/10-24	80009	384-0774-00
-21	-----		1						CKT BOARD ASSY: PUSH SWITCH(SEE A6 REPL)		
-22	131-0608-00		10						. TERMINAL, PIN: 0.365 L X 0.025 PH BRZ GOLD	22526	47357
-23	210-0702-00		30						. EYELET, METALLIC: 0.047 OD X 0.125 INCH LONG	07707	S6127
-24	214-0628-00		6						. SPRING, FLAT: PUSH BUTTON (ATTACHING PARTS FOR CKT BD ASSY)	80009	214-0628-00
-25	210-0586-00		4						NUT, PL, ASSEM WA: 4-40 X 0.25, STL CD PL	83385	OBD
-26	210-0994-00		4						WASHER, FLAT: 0.125 ID X 0.25" OD, STL	86928	5702-201-20
-27	210-1011-00		8						WASHER, NONMETAL: 0.13 ID X 0.375 " OD, PLSTC - - - * - - -	83309	OBD
-28	380-0084-00		1						HSG, PUSHBUTTON: ACETAL	80009	380-0084-00
-29	380-0220-00		1						HSG, PUSHBUTTON: 2 BTN, ACETAL	80009	380-0220-00
-30	380-0219-00		1						HSG, PUSHBUTTON: 1 BTN, ACETAL	80009	380-0219-00
-31	366-1259-03		1						PUSH BUTTON:	80009	366-1259-03
	366-1259-00		1						PUSH BUTTON:	80009	366-1259-00
	366-1259-01		1						PUSH BUTTON:	80009	366-1259-01
	366-1259-02		1						PUSH BUTTON:	80009	366-1259-02
	366-1259-04		1						PUSH BUTTON:	80009	366-1259-04
	366-1259-05		1						PUSH BUTTON:	80009	366-1259-05
-32	-----		1						CKT BOARD ASSY: CAP & RECT BRIDGE(SEE A5 REPL)		
-33	131-0589-00		2						. TERMINAL, PIN: 0.46 L X 0.025 SQ	80009	131-0589-00
-34	131-0784-00		2						. CONTACT, ELEC: 0.80 INCH LONG	00779	86182-8
-35	-----		1						. DIODE: (ATTACHING PARTS)		
-36	220-0410-00		1						. NUT, EXTENDED WA: 10-32 X 0.375 INCH, STL	83385	OBD
-37	210-1003-00		1						. WASHER, FLAT: # 10 X 0.036 THICK, BRS	12327	OBD
	210-0910-00		1						. WASHER, NONMETAL: 0.188 ID X 0.313" OD, TEFLON	02107	OBD
	210-0909-00		1						. WASHER, NONMETAL: 0.196 ID X 0.625" OD, MICA - - - * - - -	83309	OBD
-38	407-0822-00		1						. BRACKET, ANGLE: ALUMINUM (ATTACHING PARTS)	80009	407-0822-00
-39	211-0116-00		1						. SCR, ASSEM WSHR: 4-40 X 0.312 INCH, PNH BRS - - - * - - - (ATTACHING PARTS FOR CKT BD ASSY)	83385	OBD
	211-0116-00		1						SCR, ASSEM WSHR: 4-40 X 0.312 INCH, PNH BRS	83385	OBD
-40	211-0507-00		2						SCREW, MACHINE: 6-32 X 0.312 INCH, PNH STL - - - * - - -	83385	OBD
-41	426-0653-00		1						FRAME SECT, CAB: FRONT	80009	426-0653-00
-42	390-0168-00		1						COV, PL-IN HSNB: BOTTOM (ATTACHING PARTS)	80009	390-0168-00
-43	211-0503-00		6						SCREW, MACHINE: 6-32 X 0.188 INCH, PNH STL - - - * - - -	83385	OBD

Replaceable Mechanical Parts—176

Fig. & Index No.	Tektronix Part No.	Serial/Model No. Eff Dscont	Qty	1	2	3	4	5	Name & Description	Mfr Code	Mfr Part Number
1-44	390-0164-00		1						PNL, PL-IN HSNQ: RIGHT SIDE (ATTACHING PARTS)	80009	390-0164-00
-45	213-0146-00		4						SCR, TPG, THD FOR: 6-20 X 0.313 INCH, PNH STL	83385	OBD
-46	211-0504-00		2						SCREW, MACHINE: 6-32 X 0.25 INCH, PNH STL - - - * - - -	83385	OBD
-47	390-0165-00		1						PNL, PL-IN HSNQ: LEFT SIDE (ATTACHING PARTS)	80009	390-0165-00
-48	213-0146-00		4						SCR, TPG, THD FOR: 6-20 X 0.313 INCH, PNH STL	83385	OBD
-49	211-0504-00		2						SCREW, MACHINE: 6-32 X 0.25 INCH, PNH STL - - - * - - -	83385	OBD
-50	390-0163-00		1						COV, PL-IN HSNQ: TOP (ATTACHING PARTS)	80009	390-0163-00
-51	211-0503-00		3						SCREW, MACHINE: 6-32 X 0.188 INCH, PNH STL - - - * - - -	83385	OBD
-52	214-1389-00		1						ADAPTER, SW ACTR: PLASTIC (ATTACHING PARTS)	80009	214-1389-00
-53	211-0101-00		1						SCREW, MACHINE: 4-40 X 0.25, 100 DEG, FLH STL	83385	OBD
-54	210-0406-00		1						NUT, PLAIN, HEX.: 4-40 X 0.188 INCH, BRS - - - * - - -	73743	12161-50
-55	386-1551-00		1						PL, MTG, TEST ADA: 5 HOLE (ATTACHING PARTS)	80009	386-1551-00
-56	211-0038-00		3						SCREW, MACHINE: 4-40 X 0.312, FLH, 100 DEG - - - * - - -	83385	OBD
-57	131-0031-00		2						JACK, TIP: 0.635 INCH LONG W/LUG (ATTACHING PARTS)	74970	108-0740-023
-58	210-0455-00		4						NUT, PLAIN, HEX.: 0.25-28 X 0.375 INCH, BRASS	73743	3089-402
-59	210-0046-00		2						WASHER, LOCK: 0.261 ID, INTL, 0.018 THK, BRS - - - * - - -	78189	1214-05-00-0541C
	131-0031-00		3						JACK, TIP: 0.635 INCH LONG W/LUG (ATTACHING PARTS)	74970	108-0740-023
	210-0455-00		2						NUT, PLAIN, HEX.: 0.25-28 X 0.375 INCH, BRASS	73743	3089-402
	210-0223-00		1						TERMINAL, LUG: 0.25 INCH DIA, SE - - - * - - -	86928	A313-136
-60	136-0164-00		1						LAMPHOLDER: 0.375 INCH MOUNTING HOLE (ATTACHING PARTS)	75915	910-211X-241XX
-61	210-0413-00		1						NUT, PLAIN, HEX.: 0.375-32 X 0.50 INCH, STL	73743	3145-402
-62	210-0012-00		1						WASHER, LOCK: INTL, 0.375 ID X 0.50" OD STL	78189	1220-02-00-0541C
-63	220-0480-02		1						NUT, PLAIN, DODEC: 0.375-32 X 0.91 INCH, BRS	80009	220-0480-02
	210-0978-00	XB020229	1						WASHER, FLAT: 0.375 ID X 0.50 INCH OD, STL - - - * - - -	78471	OBD
-64	131-0749-00		1						CONTACT, ELEC: UPPER	80009	131-0749-00
-65	361-0259-00		1						INSULATOR, PLATE: 0.320 X 0.60 INCH	80009	361-0259-00
-66	131-0748-00		1						CONTACT, ELEC: LOWER	80009	131-0748-00
-67	337-1152-00		1						SHIELD, ELEC: PUSH SWITCH (ATTACHING PARTS)	80009	337-1152-00
-68	211-0112-00		2						SCREW, MACHINE: 2-56 X 0.375, FLH, 100 DEG	83385	OBD
-69	210-0405-00		2						NUT, PLAIN, HEX.: 2-56 X 0.188 INCH, BRS - - - * - - -	73743	12157-50
-70	343-0042-00	B010100 B010129	1						CLAMP, LOOP: 0.287 INCH DIA	95987	5-16-6BH
	343-0004-00	B010130	1						CLAMP, LOOP: 0.312 INCH DIAMETER, PLSTC (ATTACHING PARTS)	95987	5-16-6B
-71	210-0406-00		1						NUT, PLAIN, HEX.: 4-40 X 0.188 INCH, BRS	73743	12161-50
-72	210-0201-00		1						TERMINAL, LUG: 0.12 ID, LOCKING, BRZ TIN PL	86928	OBD
-73	210-0863-00		1						WSHR, LOOP CLAMP: 0.187 ID U/W 0.5 W CLP, STL - - - * - - -	95987	C191
-74	441-0949-00		1						CHAS, PL-IN UNIT: (ATTACHING PARTS)	80009	441-0949-00
	211-0541-00		4						SCREW, MACHINE: 6-32 X 0.25" 100 DEG, FLH STL	83385	OBD
	211-0038-00		1						SCREW, MACHINE: 4-40 X 0.312, FLH, 100 DEG - - - * - - -	83385	OBD
-75	131-0149-00		1						CONNECTOR, RCPT, : 24 CONTACT, MALE (ATTACHING PARTS)	02660	26-159-24
-76	211-0008-00		2						SCREW, MACHINE: 4-40 X 0.25 INCH, PNH STL	83385	OBD
-77	210-0586-00		2						NUT, PL, ASSEM WA: 4-40 X 0.25, STL CD PL - - - * - - -	83385	OBD

Replaceable Mechanical Parts—176

Fig. & Index No.	Tektronix Part No.	Serial/Model No. Eff Dscont	Qty	1	2	3	4	5	Name & Description	Mfr Code	Mfr Part Number
1-78	131-0017-00		2						CONNECTOR, RCPT, :16 CONTACT, MALE (ATTACHING PARTS)	02660	26-159-16
	211-0008-00		2						SCREW, MACHINE:4-40 X 0.25 INCH, PNH STL	83385	OBD
	210-0586-00		2						NUT, PL, ASSEM WA:4-40 X 0.25, STL CD PL - - - * - - -	83385	OBD
-79	131-0096-00		1						CONN, RCPT, ELEC: 32 CONTACT, MALE (ATTACHING PARTS)	02660	26-159-32
	211-0008-00		2						SCREW, MACHINE:4-40 X 0.25 INCH, PNH STL	83385	OBD
	210-0586-00		2						NUT, PL, ASSEM WA:4-40 X 0.25, STL CD PL - - - * - - -	83385	OBD
-80	426-0654-00		1						FRAME SECT, CAB: REAR	80009	426-0654-00
-81	210-0286-00		2						TERMINAL, LUG: 0.25 OD, RING, SOLDERLESS, CU PL	00779	33461

Replaceable Mechanical Parts—176

Fig. & Index No.	Tektronix Part No.	Serial/Model No. Eff	Dscont	Qty	1 2 3 4 5	Name & Description	Mfr Code	Mfr Part Number
2-1	-----			10		COIL: (ATTACHING PARTS)		
-2	211-0626-00			8		SCREW,CAP:6-32 X 0.312,BTN HD,STL	56878	OBD
-3	220-0419-00			8		NUT,PLAIN,SQ:6-32 X 0.312 INCH,STL	83385	OBD
	211-0511-00			2		SCREW,MACHINE:6-32 X 0.500,PNH,STL,CD PL	83385	OBD
						- - - * - - -		
-4	432-0069-00			2		BASE,COIL MTG: (ATTACHING PARTS)	80009	432-0069-00
-5	211-0504-00			4		SCREW,MACHINE:6-32 X 0.25 INCH,PNH STL	83385	OBD
						- - - * - - -		
-6	-----			1		CKT BOARD ASSY:15 VOLT LINE(SEE A3 REPL)		
-7	407-0792-00			10		. BRACKET,CAP.:BRASS CU-SN-ZN PL	80009	407-0792-00
						(ATTACHING PARTS FOR CKT BD ASSY)		
-8	211-0116-00			4		SCR,ASSEM WSHR:4-40 X 0.312 INCH,PNH BRS	83385	OBD
						- - - * - - -		
-9	131-0973-00			1		BUS,CONDUCTOR:0.094 X 5.6 LW/0.965 L	80009	131-0973-00
-10	-----			1		CKT BOARD ASSY:75 VOLT LINE(SEE A4 REPL)		
-11	210-1014-00			5		. WASHER,NONMETAL:0.094 ID X 0.312" OD,TEFLON	80009	210-1014-00
-12	-----			1		CKT BOARD ASSY:350 VOLTS LINE(SEE A2 REPL)		
						(ATTACHING PARTS FOR CKT BD ASSY)		
-13	211-0027-00			2		SCREW,MACHINE:4-40 X 1.50 INCH,PNH STL	83385	OBD
-14	210-0994-00			2		WASHER,FLAT:0.125 ID X 0.25" OD,STL	86928	5702-201-20
-15	343-0280-00			4		RETAINER,CKT BD:PLASTIC	80009	343-0280-00
						- - - * - - -		
-16	131-0942-00			1		CONTACT,ELEC:GROUNDING (ATTACHING PARTS)	80009	131-0942-00
-17	213-0138-00			1		SCR,TPG,TF:4-24 X 0.188 INCH,PNH STL	83385	OBD
						- - - * - - -		
-18	129-0275-00			1		SPACER,POST:2.278 L W/4-40 THD EA END	80009	129-0275-00
-19	129-0129-00			1		SPACER,POST:0.25 HEX X 1.125"L,W/4-40 THD	80009	129-0129-00
-20	348-0115-00			1		GROMMET,PLASTIC:U-SHP,0.548 X0.462 INCH	80009	348-0115-00
-21	-----			5		COIL: (ATTACHING PARTS)		
-22	211-0510-00			20		SCREW,MACHINE:6-32 X 0.375,PNH,STL,CD PL	83385	OBD
-23	211-0578-00	B010100	B040000X	10		SCREW,MACHINE:6-32 X 0.438 INCH,PNH STL	83385	OBD
-24	342-0034-00	B010100	B040000X	10		INSULATOR BSHG:0.145 X 0.22 L,PLASTIC	80009	342-0034-00
-25	343-0284-00			5		HOLD-DOWN,COIL:PLASTIC	80009	343-0284-00
-26	432-0069-00			5		BASE,COIL MTG:	80009	432-0069-00
-27	220-0419-00	B010100	B040000X	15		NUT,PLAIN,SQ:6-32 X 0.312 INCH,STL	83385	OBD
	211-0551-00			15		SCREW,MACHINE:6-32 X 0.562 INCH,PNH STL	83385	OBD
						- - - * - - -		
-28	-----			4		RELAY: (ATTACHING PARTS)		
-29	211-0007-00			16		SCREW,MACHINE:4-40 X 0.188 INCH,PNH STL	83385	OBD
						- - - * - - -		
-30	-----			1		CKT BOARD ASSY:MAIN(SEE A1 REPL)		
-31	136-0183-00			7		. SOCKET,PLUG-IN:3 PIN,ROUND	80009	136-0183-00
-32	136-0220-00			26		. SKT,PL-IN ELEK:TRANSISTOR 3 CONTACT,PCB MT	71785	133-23-11-034
-33	136-0235-00			2		. SOCKET,PLUG-IN:6 CONTACT,ROUND	71785	133-96-12-062
-34	136-0393-00			8		. SOCKET,PLUG-IN:16 PIN	77342	27E710 W/20C250
	214-3047-00			8		. RTNR,ELEC RELAY:STAINLESS STEEL	77342	20C250
-35	136-0394-00			4		. SOCKET,PLUG-IN:10 PIN,CKT CD MTG	12300	27E709 W/20C249
-36	131-0589-00			65		. TERMINAL,PIN:0.46 L X 0.025 SQ	80009	131-0589-00
	131-0784-00			12		. CONTACT,ELEC:0.80 INCH LONG	00779	86182-8
						(ATTACHING PARTS FOR CKT BD ASSY)		
-37	211-0116-00			7		SCR,ASSEM WSHR:4-40 X 0.312 INCH,PNH BRS	83385	OBD
						- - - * - - -		
-38	-----			1		TRANSFORMER: (ATTACHING PARTS)		
-39	211-0021-00			2		SCREW,MACHINE:4-40 X 1.25 INCH,PNH STL	83385	OBD
-40	210-0054-00			2		WASHER,LOCK:SPLIT,0.118 ID X 0.212"OD STL	83385	OBD
-41	210-0406-00			2		NUT,PLAIN,HEX.:4-40 X 0.188 INCH,BRS	73743	12161-50
						- - - * - - -		

Fig. & Index No.	Tektronix Part No.	Serial/Model No. Eff Dscont	Qty	1	2	3	4	5	Name & Description	Mfr Code	Mfr Part Number
2-42	-----	-----	1						DIODE: (ATTACHING PARTS)		
-43	220-0410-00		1						NUT, EXTENDED WA:10-32 X 0.375 INCH, STL	83385	OBD
-44	210-0805-00		1						WASHER, FLAT:0.204 ID X 0.438 INCH OD, STL	12327	OBD
-45	210-0909-00		2						WASHER, NONMETAL:0.196 ID X 0.625" OD, MICA	83309	OBD
	210-0910-00		1						WASHER, NONMETAL:0.188 ID X 0.313" OD, TEFLON	02107	OBD
-46	210-0224-00		1						TERMINAL, LUG:0.20 ID X 0.344 OD, SE, BRS	86928	A373-148-1
									- - - * - - -		
-47	-----	-----	2						TRANSISTOR: (ATTACHING PARTS)		
-48	211-0511-00		4						SCREW, MACHINE:6-32 X 0.500, PNH, STL, CD PL	83385	OBD
-49	386-0978-00		2						INSULATOR, PLATE:TRANSISTOR, MICA	80009	386-0978-00
-50	210-0967-00		4						WASHER, SHLDR:0.156 ID X 0.094D X 0.375 OD	86928	5607-82
	210-0803-00		4						WASHER, FLAT:0.15 ID X 0.032 THK, STL CD PL	12327	OBD
-52	210-0202-00		2						TERMINAL, LUG:0.146 ID, LOCKING, BRZ TINNED	78189	2104-06-00-2520N
-53	210-0457-00		4						NUT, PL, ASSEM WA:6-32 X 0.312 INCH, STL	83385	OBD
									- - - * - - -		
-54	-----	-----	1						TRANSISTOR: (ATTACHING PARTS)		
-55	211-0510-00		2						SCREW, MACHINE:6-32 X 0.375, PNH, STL, CD PL	83385	OBD
	210-0202-00		1						TERMINAL, LUG:0.146 ID, LOCKING, BRZ TINNED	78189	2104-06-00-2520N
-56	210-0457-00		2						NUT, PL, ASSEM WA:6-32 X 0.312 INCH, STL	83385	OBD
									- - - * - - -		
-57	407-0787-00		1						BRACKET, CMPNT:ALUMINUM (ATTACHING PARTS)	80009	407-0787-00
-58	211-0507-00		2						SCREW, MACHINE:6-32 X 0.312 INCH, PNH STL	83385	OBD
-59	210-0202-00		1						TERMINAL, LUG:0.146 ID, LOCKING, BRZ TINNED	78189	2104-06-00-2520N
									- - - * - - -		
-60	-----	-----	1						TRANSISTOR: (ATTACHING PARTS)		
-61	211-0511-00		2						SCREW, MACHINE:6-32 X 0.500, PNH, STL, CD PL	83385	OBD
-62	386-0978-00		1						INSULATOR, PLATE:TRANSISTOR, MICA	80009	386-0978-00
-63	210-0967-00		2						WASHER, SHLDR:0.156 ID X 0.094D X 0.375 OD	86928	5607-82
	210-0803-00		2						WASHER, FLAT:0.15 ID X 0.032 THK, STL CD PL	12327	OBD
-64	210-0202-00		1						TERMINAL, LUG:0.146 ID, LOCKING, BRZ TINNED	78189	2104-06-00-2520N
	210-0457-00		1						NUT, PL, ASSEM WA:6-32 X 0.312 INCH, STL	83385	OBD
-65	131-0775-00		1						CONTACT, ELEC:HEX, 0.25 INCH W/6-32 1 END	88245	1601-A
									- - - * - - -		
-66	-----	-----	1						TRANSISTOR: (ATTACHING PARTS)		
-67	211-0511-00		2						SCREW, MACHINE:6-32 X 0.500, PNH, STL, CD PL	83385	OBD
-68	210-0202-00		2						TERMINAL, LUG:0.146 ID, LOCKING, BRZ TINNED	78189	2104-06-00-2520N
-69	386-0978-00		1						INSULATOR, PLATE:TRANSISTOR, MICA	80009	386-0978-00
-70	210-0967-00		2						WASHER, SHLDR:0.156 ID X 0.094D X 0.375 OD	86928	5607-82
-71	210-0803-00		2						WASHER, FLAT:0.15 ID X 0.032 THK, STL CD PL	12327	OBD
-72	210-0457-00		2						NUT, PL, ASSEM WA:6-32 X 0.312 INCH, STL	83385	OBD
									- - - * - - -		
-73	-----	-----	1						RESISTOR: (ATTACHING PARTS)		
-74	211-0514-00		1						SCREW, MACHINE:6-32 X 0.750 INCH, PNH STL	83385	OBD
-75	210-0601-00		1						EYELET, METALLIC:CAD PLATED	18680	A424
-76	210-0478-00		1						INSERT, SCR THD:0.66" L, W/HEX FLG ONE END	80009	210-0478-00
-77	210-0006-00		1						WASHER, LOCK:#6 INTL, 0.018THK, STL CD PL	78189	1206-00-00-0541C
-78	211-0507-00		1						SCREW, MACHINE:6-32 X 0.312 INCH, PNH STL	83385	OBD
									- - - * - - -		
-79	-----	-----	1						DIODE: (ATTACHING PARTS)		
-80	210-0455-00		1						NUT, PLAIN, HEX.:0.25-28 X 0.375 INCH, BRASS	73743	3089-402
-81	210-0046-00		1						WASHER, LOCK:0.261 ID, INTL, 0.018 THK, BRS	78189	1214-05-00-0541C
									- - - * - - -		
-82	-----	-----	1						DIODE: (ATTACHING PARTS)		
-83	210-0455-00		1						NUT, PLAIN, HEX.:0.25-28 X 0.375 INCH, BRASS	73743	3089-402
-84	210-0269-00		1						TERMINAL, LUG:NON LOCKING, 0.257" MTG HOLE	78584	905-020
	210-0905-00		1						WASHER, FLAT:0.256 ID X 0.05 THK, BRS	83385	OBD
-85	210-0904-00		1						WASHER, SHLDR:0.255 ID X 0.1 D, FIBER, 0.5 OD	74921	OBD
-86	342-0044-00		1						INSULATOR, WSHR:0.26 ID X 8.55 INCH OD, MICA	08530	OBD
-87	210-0254-00		1						TERMINAL, LUG:0.25 ID, PLAIN, BRASS	91886	OBD
									- - - * - - -		

Replaceable Mechanical Parts—176

Fig. & Index No.	Tektronix Part No.	Serial/Model No. Eff	Dscont	Qty	1 2 3 4 5	Name & Description	Mfr Code	Mfr Part Number
2-88	-----	-----		1		DIODE: (ATTACHING PARTS)		
-89	210-0455-00			1		NUT, PLAIN, HEX.: 0.25-28 X 0.375 INCH, BRASS	73743	3089-402
-90	210-0046-00			1		WASHER, LOCK: 0.261 ID, INTL, 0.018 THK, BRS	78189	1214-05-00-0541C
-91	210-0254-00			1		TERMINAL, LUG: 0.25 ID, PLAIN, BRASS - - - * - - -	91886	OBD
-92	214-1388-00			1		HEAT SINK, ELEC: (ATTACHING PARTS)	80009	214-1388-00
-93	211-0033-00			4		SCR, ASSEM WSHR: 4-40 X 0.312 PNH, STL, CD PL	83385	OBD
-94	385-0012-00			2		SPACER, POST: 0.312 OD, 0.562 L W/8-32 THD - - - * - - -	80009	385-0012-00
-95	210-0285-00			2		TERMINAL, LUG:	00779	321051
-96	441-0948-00			1		CHAS, PL-IN UNIT: MAIN (ATTACHING PARTS)	80009	441-0948-00
	211-0507-00			4		SCREW, MACHINE: 6-32 X 0.312 INCH, PNH STL	83385	OBD
	211-0538-00			3		SCREW, MACHINE: 6-32 X 0.312"100 DEG, FLH STL - - - * - - -	83385	OBD
-97	179-1592-00			1		WIRING HARNESS: MAIN	80009	179-1592-00
	-----			-		. WIRING HARNESS INCLUDES:		
-98	131-0621-00			43		. CONNECTOR, TERM: 22-26 AWG, BRS& CU BE GOLD	22526	46231
	131-0707-00			9		. CONNECTOR, TERM: 22-26 AWG, BRS& CU BE GOLD	22526	47439
-99	131-0738-00			8		. CONNECTOR, TERM.: FOR 18-20 AWGWIRE	00779	61616-2
-100	131-0792-00			10		. CONNECTOR, TERM: 18-20 AWG, CU BE GOLD PL	22526	46221
-101	352-0168-00			1		. CONN BODY, PL, EL: 10 WIRE BLACK	80009	352-0168-00
-102	352-0198-00			1		. HLDR, TERM CONN: 2 WIRE BLACK	80009	352-0198-00
-103	352-0199-00			3		. CONN BODY, PL, EL: 3 WIRE BLACK	80009	352-0199-00
-104	352-0200-00			1		. HLDR, TERM CONN: 4 WIRE BLACK	80009	352-0200-00
-105	352-0202-00			1		. HLDR, TERM CONN: 6 WIRE BLACK	80009	352-0202-00
-106	352-0203-00			1		. HLDR, TERM CONN: 7 WIRE BLACK	80009	352-0203-00
-107	352-0204-00			3		. CONN BODY, PL, EL: 8 WIRE BLACK	80009	352-0204-00
	179-1593-00			1		WIRING HARNESS: S C - . WIRING HARNESS INCLUDES:	80009	179-1593-00
	131-0621-00			12		. CONNECTOR, TERM: 22-26 AWG, BRS& CU BE GOLD	22526	46231
	352-0202-00			1		. HLDR, TERM CONN: 6 WIRE BLACK	80009	352-0202-00
	352-0203-00			1		. HLDR, TERM CONN: 7 WIRE BLACK	80009	352-0203-00
STANDARD ACCESSORIES								
-108	013-0112-00			1		ADAPTER, TEST: TO-36	80009	013-0112-00
-109	337-1194-00			1		SHIELD, ELEC: TRANSISTOR	80009	337-1194-00
	337-1120-02	XB050000		1		SHIELD, ELEC: GUARD BOX (ATTACHING PARTS)	80009	337-1120-02
	211-0558-00	XB050000		4		SCREW, MACHINE: 6-32 X 0.250 BDGH, NYL, SLOT - - - * - - -	26365	921-1150-0014
	070-1073-00			1		MANUAL, TECH: SERVICE	80009	070-1073-00
	013-0110-00			1		ADAPTER, TEST: DO-4, DO-5 DIODES	80009	013-0110-00